

Torre Eiffel

Libretto 1

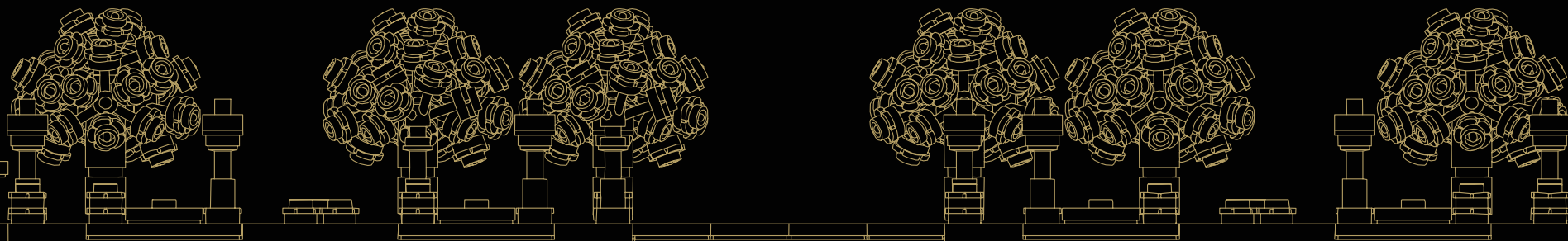



We're transitioning from single-use plastic to paper-based packaging. As we progress, you may find a mix of paper and plastic in our boxes.

Wir stellen von Einwegkunststoff-Verpackungen auf Verpackungen auf Papierbasis um. Möglicherweise findest du in der Übergangszeit sowohl Papier als auch Kunststoff in unseren Boxen.

Nous passons progressivement des emballages en plastique à usage unique aux emballages à base de papier. Au cours de cette transition, il est possible que vous trouviez à la fois du papier et du plastique dans nos boîtes.

Stiamo passando dalla plastica monouso agli imballaggi basati su carta. In questo periodo, potrete trovare un mix di carta e di plastica nelle nostre confezioni.

Estamos cambiando las bolsas de plástico desechables por bolsas con base de papel. Conforme avanzamos en este propósito, puede que encuentres una mezcla de papel y de plástico en nuestras cajas.

Estamos a fazer a transição do uso de plástico descartável nas embalagens por embalagens à base de papel. À medida que progredimos nesta transição poderá encontrar um misto de papel e plástico nas nossas caixas

Átállunk az egyszer használatos műanyagról a papír alapú csomagolásra. Az átállás folyamatos, ezért előfordulhat, hogy papír és műanyag zacskót egyaránt találás a dobozainkban.

Mēs pārejam no vienreizlietojamās plastmasas uz iepakojumu, kurā izmantots papīrs. Pārejas procesa laikā kārbās var būt gan papīra, gan plastmasas daļas.

Facem tranziția de la ambalajele de unică folosință din material plastic la ambalaje pe bază de hârtie. Pe măsură ce avansăm, s-ar putea să găsești un amestec de hârtie și material plastic în cutiile noastre.

我们正在从一次性塑料包装向纸质包装过渡。在此过程中，你可能会发现我们同时采用纸质包装和塑料包装！

Torre Eiffel

La Torre Eiffel (*La tour Eiffel*) è la suggestiva struttura a traliccio di ferro situata sul Champ de Mars nella capitale francese. Prende il nome dall'ingegnere Gustave Eiffel, la cui azienda progettò e costruì la torre come imponente ingresso dell'Exposition Universelle, la Fiera mondiale, del 1889. Con un'altezza di 324 m, è una delle strutture più riconoscibili al mondo e un simbolo iconico sia della città di Parigi sia della Francia.



L'idea originale

Quando fu deciso di celebrare il centenario della Rivoluzione francese con una Fiera mondiale, fu lanciato un concorso ufficiale per trovare un simbolo idoneo a rappresentanza della grande occasione. Tra i 107 diversi progetti presentati, il comitato selezionò la visione di Gustave Eiffel che prevedeva la costruzione di una torre di ferro alta 300 m.

Due dei suoi ingegneri, Maurice Koechlin ed Emile Nouguier, avevano già un'idea per realizzare un grande pilone con quattro colonne di travi reticolari separate che confluivano nella parte superiore. L'architetto dell'azienda, Stephen Sauvestre, propose quindi piedistalli in pietra per adornare le "gambe" e archi decorativi per collegare le colonne al primo livello.

Gustave Eiffel si augurava che la struttura sarebbe diventata il simbolo *"non solo dell'arte dell'ingegneria moderna, ma anche del secolo dell'industria e della scienza in cui viviamo"*.

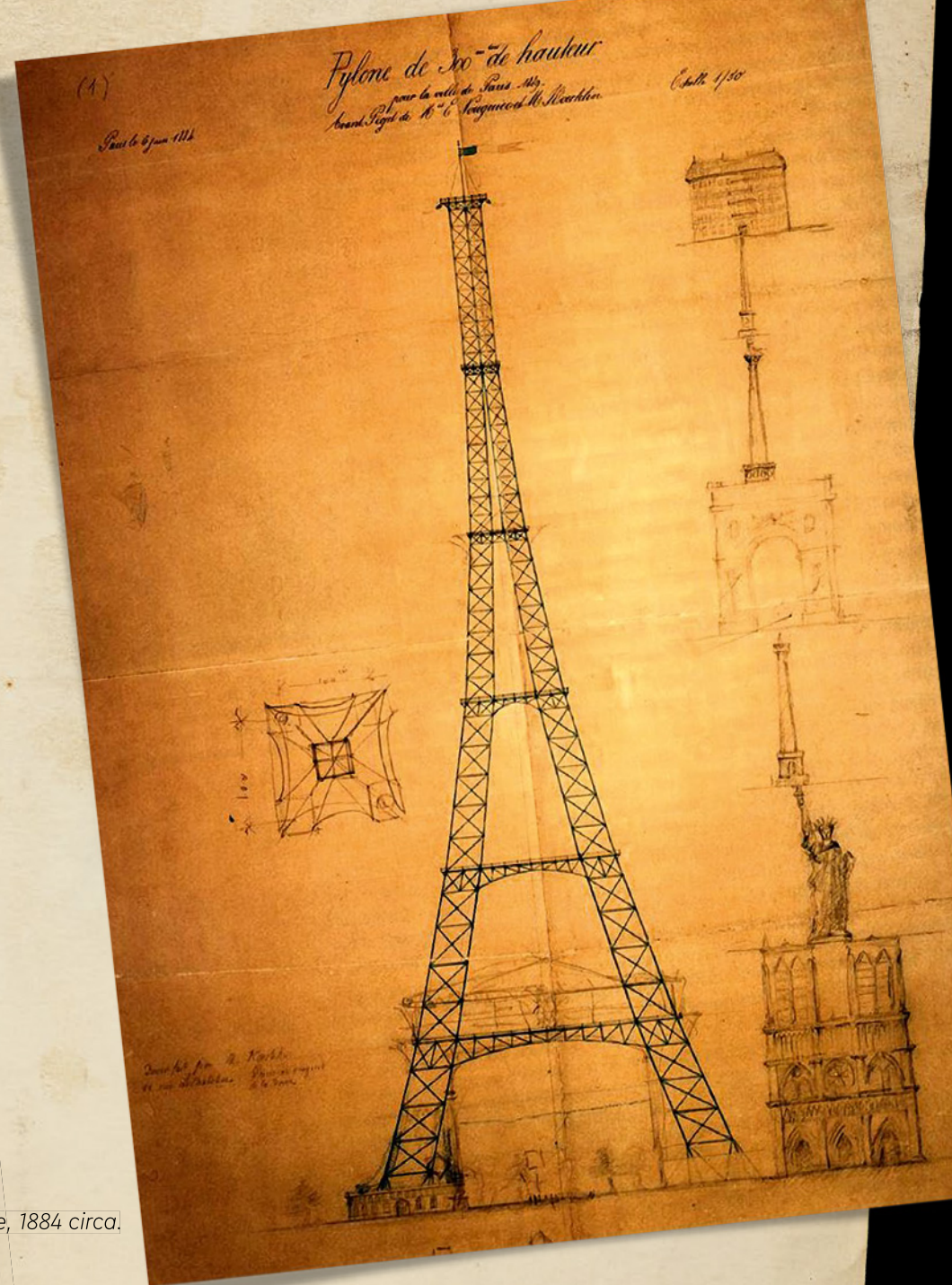

Uno dei primi disegni della torre, 1884 circa.

Gustave Eiffel

(1832 – 1923)

Nato il 15 dicembre 1832, a Digione, Francia, Gustave Eiffel era un ingegnere e costruttore eccezionalmente dotato. Laureatosi all'École Centrale des Arts et Manufactures nel 1855, nel 1864 fondò la propria impresa edile,

la quale raggiunse una certa notorietà nel settore grazie alla realizzazione di numerose e diverse strutture di metallo, tra cui ponti ferroviari e viadotti, fino alla struttura interna della Statua della Libertà. La società di Eiffel divenne famosa in particolare per l'ingegno e l'inventiva dei suoi progetti, che culminarono nella costruzione della Torre Eiffel.

**“Dovrei essere geloso della torre.
È più famosa di me”.**

GUSTAVE EIFFEL



Lavori in corso

La società di Gustave Eiffel produsse oltre cinquemila disegni in preparazione per il montaggio dei 18.038 singoli pezzi che avrebbero formato la torre. I lavori alle fondamenta iniziarono nel gennaio 1887 e il 1° luglio dello stesso anno fu avviato l'assemblaggio della torre.

Tutti gli elementi furono preparati nella fabbrica di Eiffel, a Levallois-Perret, alle porte di Parigi. I pezzi furono movimentati tramite gru a vapore, le quali si arrampicavano sulla torre durante la costruzione.

La struttura fu completata dopo due anni, due mesi e cinque giorni e, nel marzo 1889, Eiffel guidò un gruppo di funzionari governativi e la stampa in cima alla torre più alta del mondo. Poiché gli ascensori non erano ancora in funzione, il gruppo salì a piedi, impiegando più di un'ora a raggiungere la cima. Qui Eiffel issò un grande tricolore, a cui fecero seguito 25 salve di saluto.

Gustave Eiffel costruì un piccolo appartamento per sé in cima alla torre per intrattenere gli ospiti. È ora aperto al pubblico, completo di decorazioni d'epoca e delle riproduzioni realistiche di Eiffel e di alcuni dei suoi illustri ospiti sotto forma di manichini.

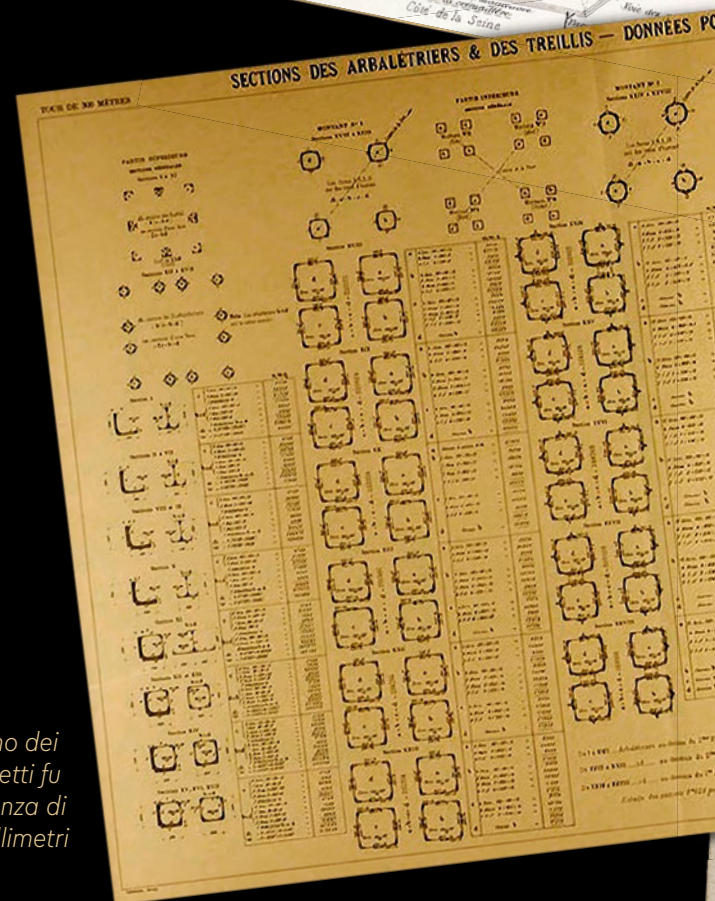
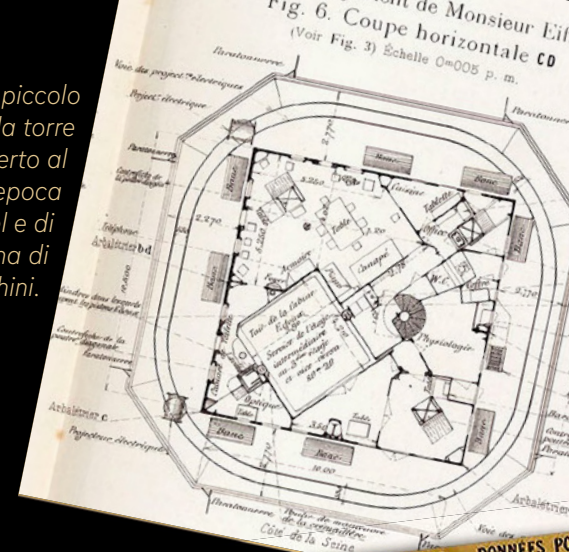

La posizione di ciascuno dei 2.500.000 fori per i rivetti fu specificata con una tolleranza di soli 0,1 millimetri

Tel

Essai

Transmission

Loi de la corde

Change de direction

Calcul de l'effort

Abolition b d

Calcul de l'effort

Calcul de l'effort

Calcul de l'effort

Calcul de l'effort

LE CALCUL DE L'OSSATURE

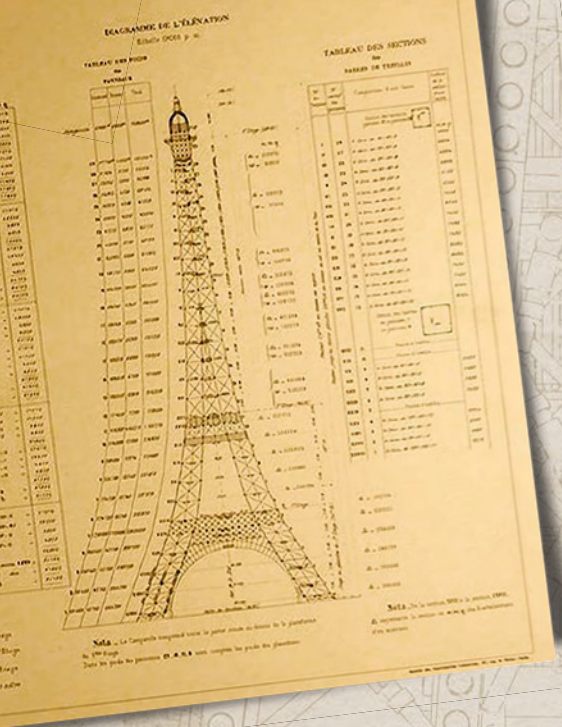

7 dicembre 1887



20 marzo 1888



15 maggio 1888

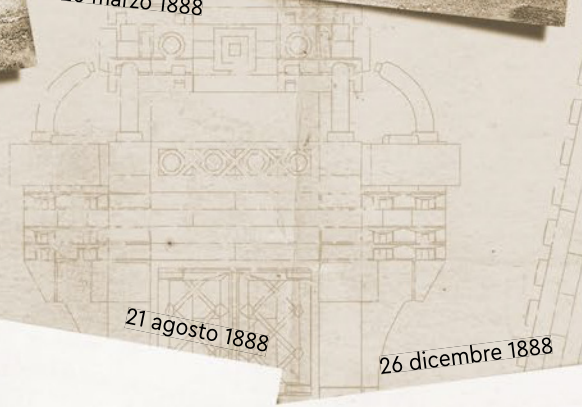

21 agosto 1888

15 marzo 1889

26 dicembre 1888



La torre funge da ingresso alla Fiera mondiale

Exposition Universelle 1889

All'*Exposition Universelle* del 1889 parteciparono oltre 61.000 espositori individuali, 25.000 dei quali provenienti dall'estero; i temi principali della fiera furono scienza, tecnologia, ingegneria industriale e belle arti. La Fiera si estendeva su due grandi siti della città e richiamò 32 milioni di visitatori nel corso dei sei mesi in cui rimase aperta. La Torre Eiffel fu un immediato successo di pubblico e lunghe code si formavano ogni giorno per visitare l'enorme struttura di ferro. I biglietti costavano due franchi per il primo livello, tre per il secondo e cinque per il primo, con ingresso a metà prezzo la domenica. Al termine della Fiera nell'ottobre 1889, la sola torre aveva richiamato quasi due milioni di visitatori.

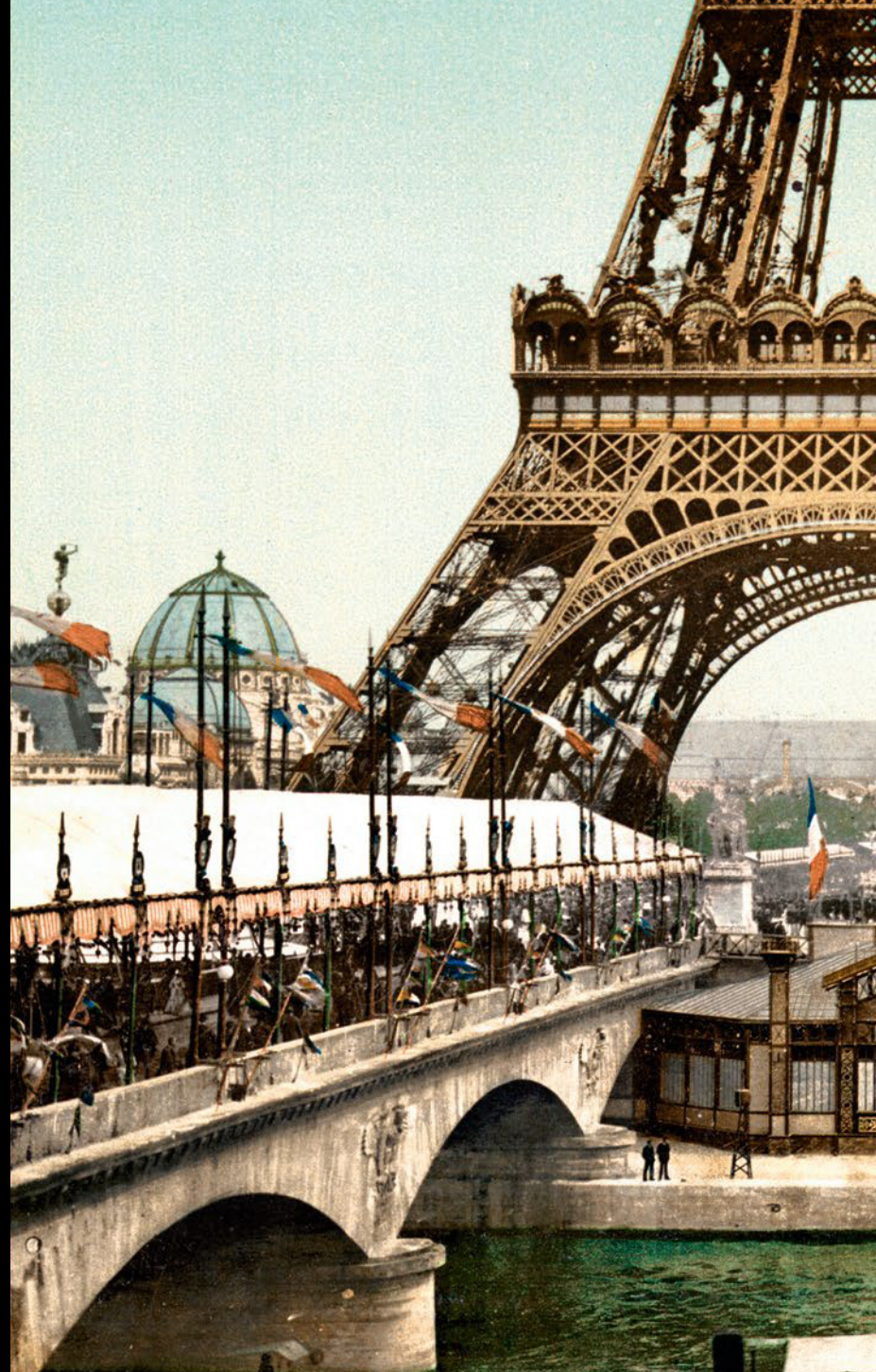



La struttura più alta del mondo

Costruttori, architetti e ingegneri hanno sempre cercato di raggiungere le stelle, realizzando altissimi edifici. Man mano che gli strumenti e le tecnologie migliorarono nel tempo, anche la portata e l'entità di questi sforzi aumentarono. La Torre Eiffel fu la prima struttura al mondo a superare sia i 200 metri sia i 300 metri di altezza, diventando la struttura artificiale più alta quando fu completata nel 1889. Sarebbe rimasta tale fino al 1930, quando fu inaugurato il Chrysler Building di 319 m a New York, negli Stati Uniti.

Da allora ad oggi

A Eiffel era stato concesso un permesso di soli vent'anni, dopodiché la torre sarebbe stata smantellata. Ma Eiffel riuscì a convincere il governo di Parigi che la struttura era molto importante per le comunicazioni e anche da un punto di vista puramente scientifico e quindi la torre non fu più abbattuta. Furono installati un laboratorio meteorologico e una piccola galleria del vento e furono effettuati oltre 5.000 test scientifici. Con l'avvento della telegrafia senza fili, la parte superiore della torre fu modificata per ospitare un numero sempre crescente di antenne, più un'antenna televisiva che portò l'altezza della torre a 324 metri.

Oggi la Torre Eiffel accoglie più visitatori di qualsiasi altro monumento a pagamento al mondo: circa sette milioni di persone all'anno. Circa cinquecento dipendenti gestiscono le operazioni quotidianamente, assicurando che le folle possano godersi la vista panoramica sulla città in piena tranquillità e sicurezza.





“È possibile pensare che, essendo solo degli ingegneri, la bellezza non sia importante per noi o che non cerchiamo di costruire strutture belle, oltre che solide e durevoli?”

GUSTAVE EIFFEL



“Ho avuto la fortuna di essere salito in cima alla Torre Eiffel due volte da bambino”.

ROK ZGALIN KOBE

Il Design Team

Il Senior Designer LEGO®, Rok Zgalin Kobe, ha fatto parte del team che ha dato vita a questa versione LEGO dell'iconica Torre Eiffel.

“Il mio obiettivo è stato fondere la grande esecuzione LEGO con i principi di progettazione della torre originale. Ho cercato di seguire i principi strutturali della vera torre il più fedelmente possibile, per quanto consentito dal sistema LEGO. Ad esempio, le capriate portanti sul modello sono posizionate proprio come sull'originale. E proprio, come nella struttura originale, la fase critica della costruzione LEGO è unire le gambe al primo livello.

La sfida più grande di un set di queste dimensioni è renderlo stabile e costruibile e tradurre il modello finale nel flusso logico di una guida con le istruzioni per la costruzione LEGO. Dobbiamo sempre garantire che sia facile da seguire, senza errori, e allo stesso tempo che sia una costruzione abbastanza impegnativa da coinvolgere il fan durante tutto il processo.

Sono onorato di aver svolto un importante ruolo nel tradurre una delle strutture più riconoscibili della storia umana in un modello LEGO. Ho già realizzato versioni più piccole della torre, ma questo, il modello LEGO più alto fino ad oggi, è molto diverso in scala!”



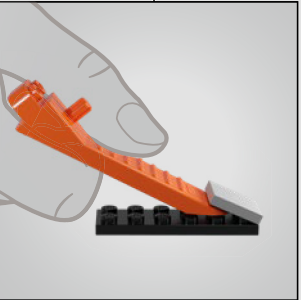
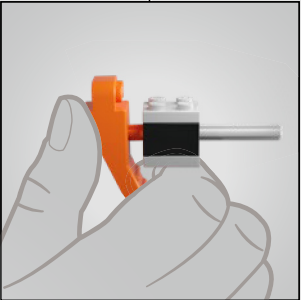
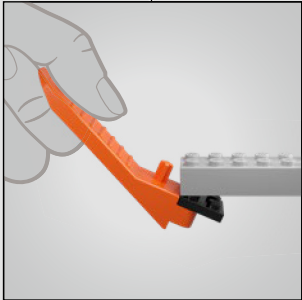
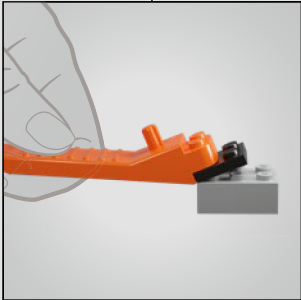
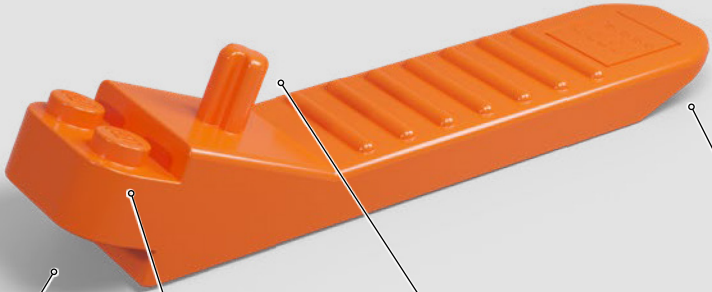

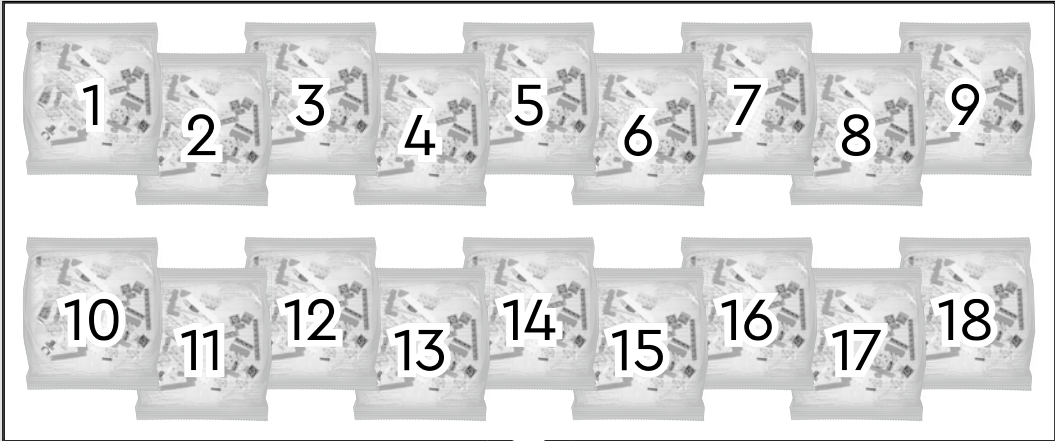

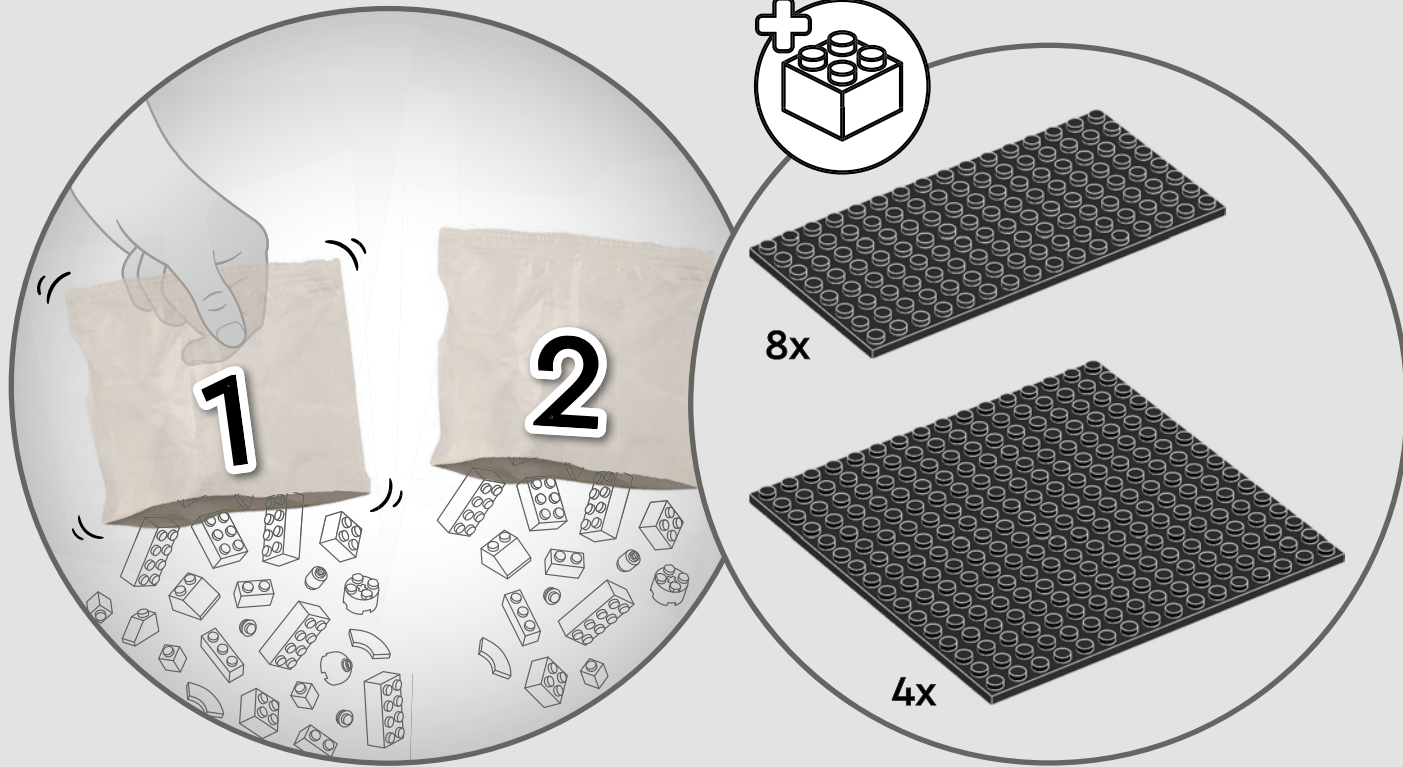



La costruzione della Torre Eiffel è costata quasi 8 milioni di franchi francesi d'oro, o 1.163 milioni di euro.

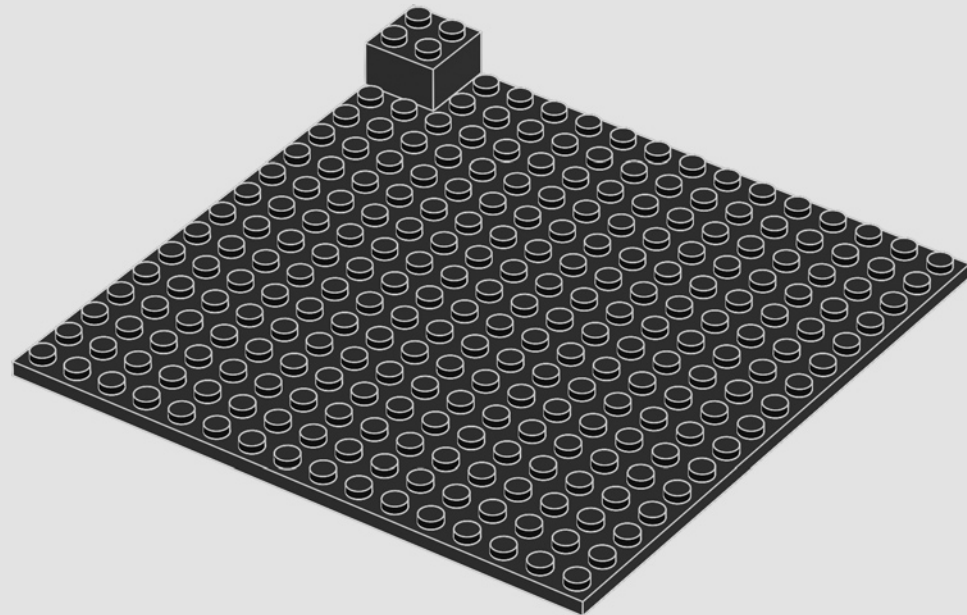
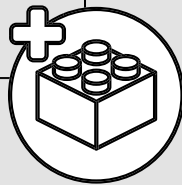
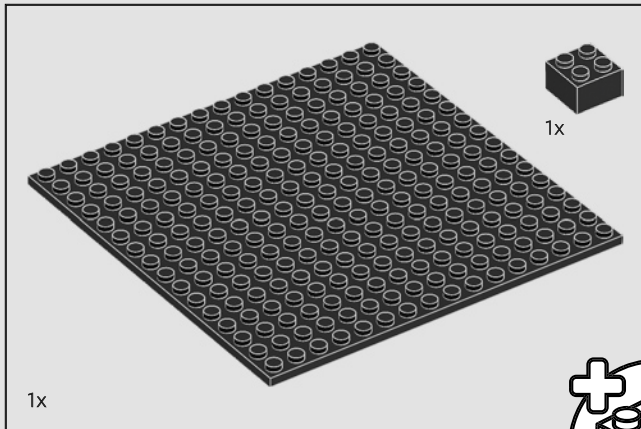
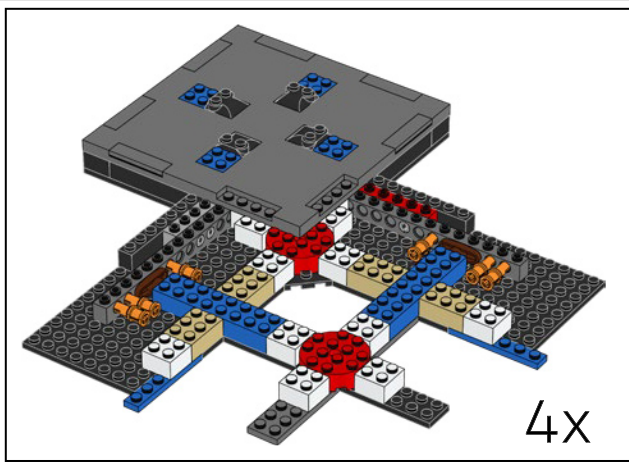

1

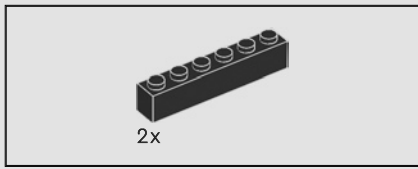

2

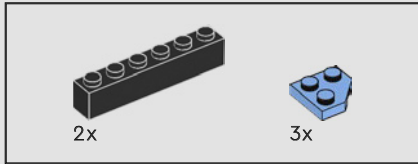
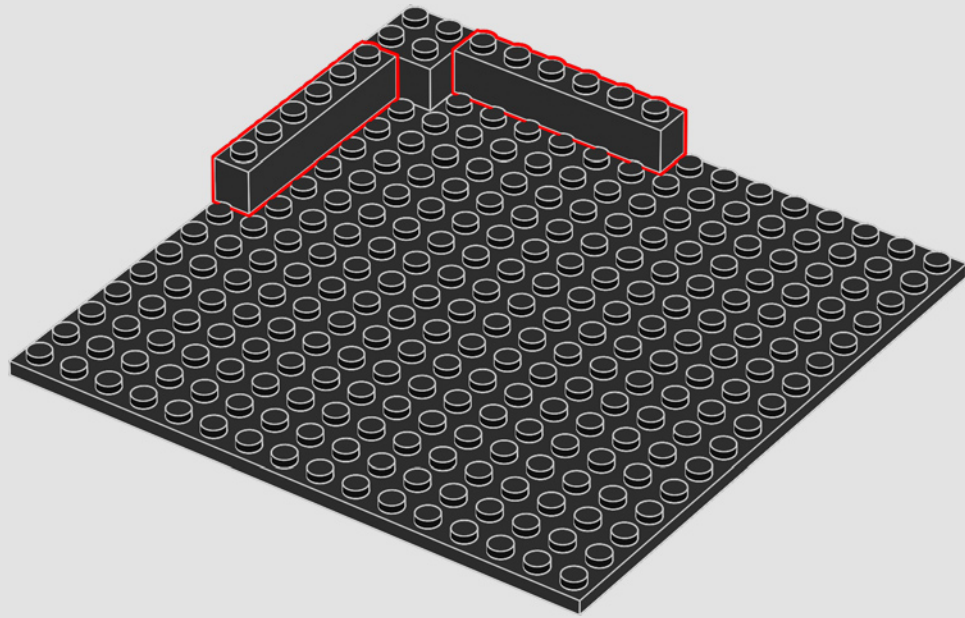

3

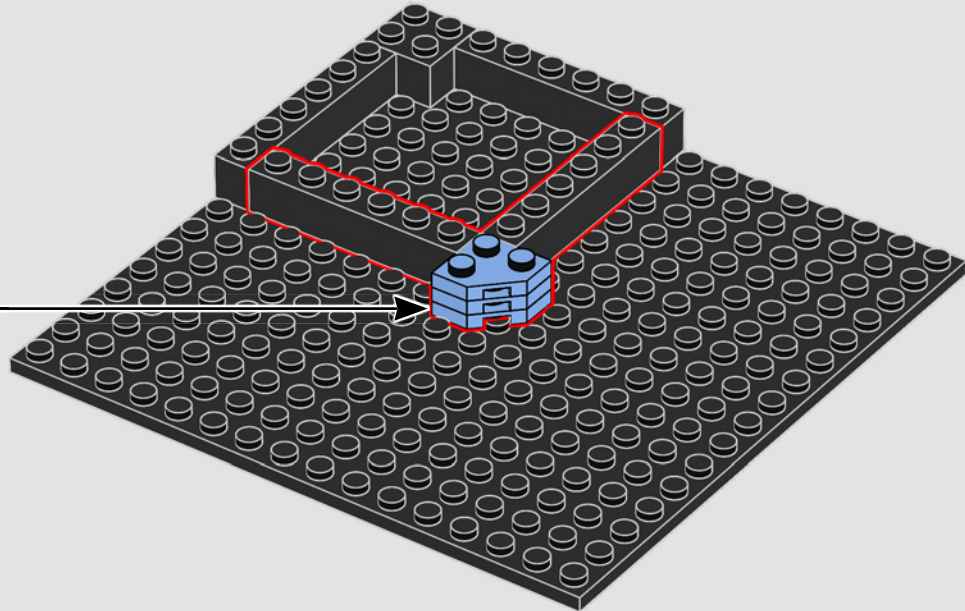
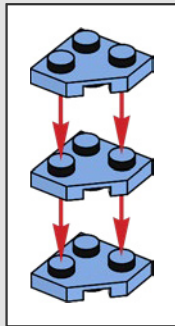

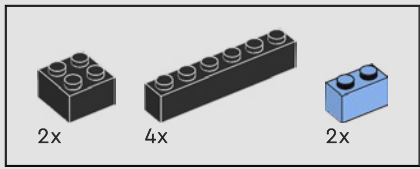

4

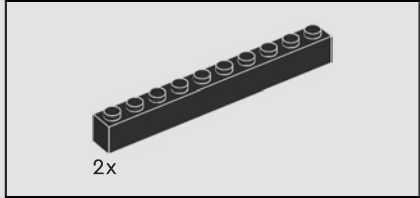
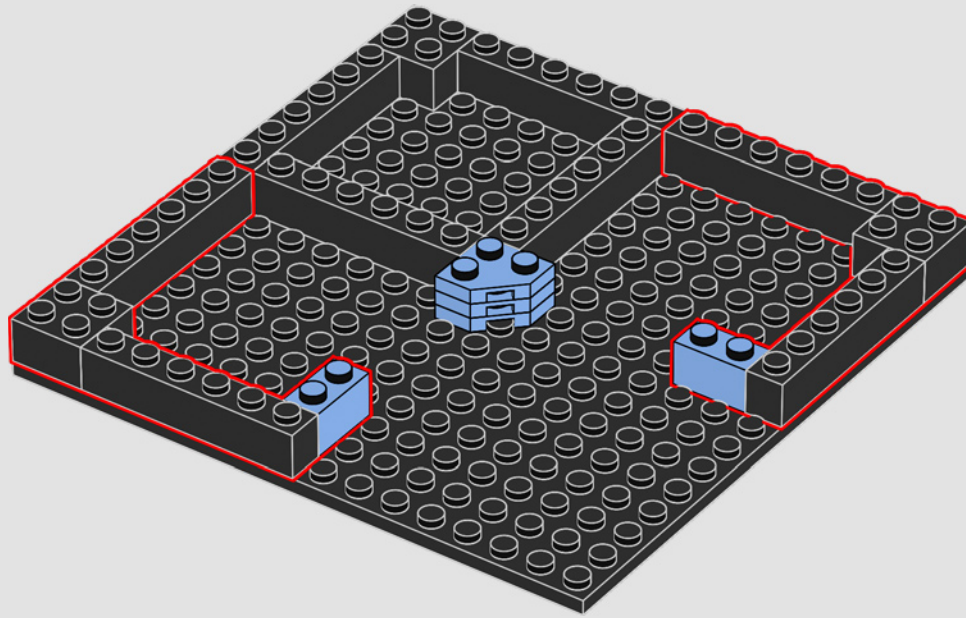

5

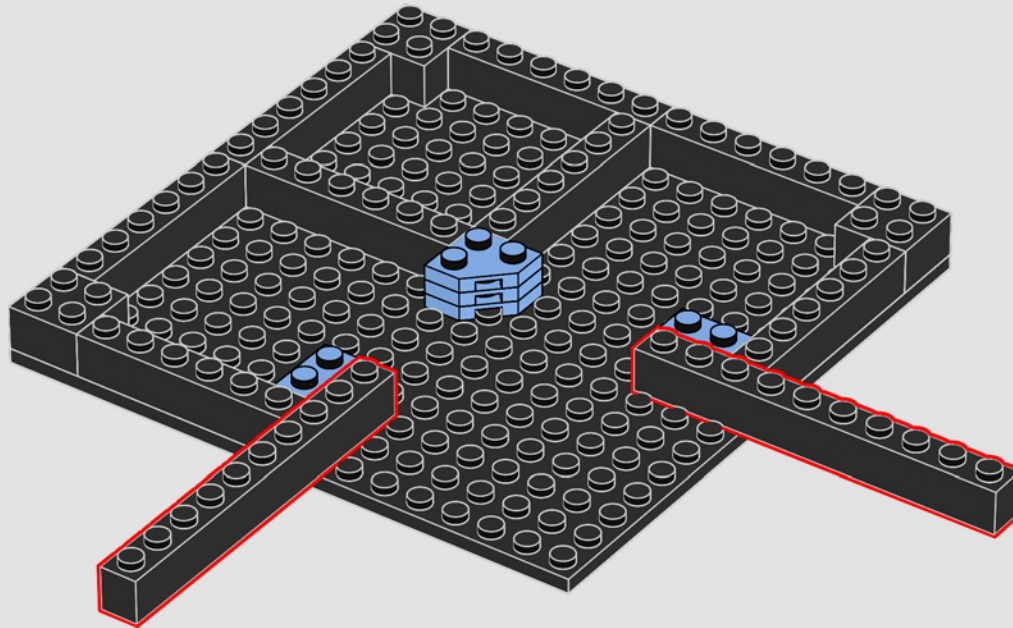

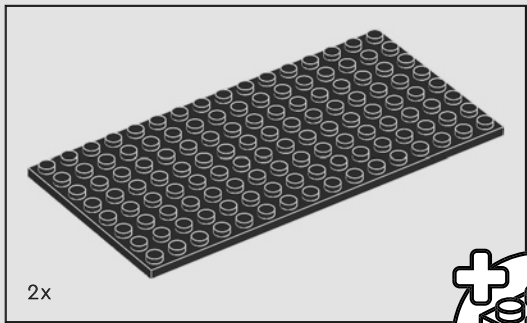

2x

6

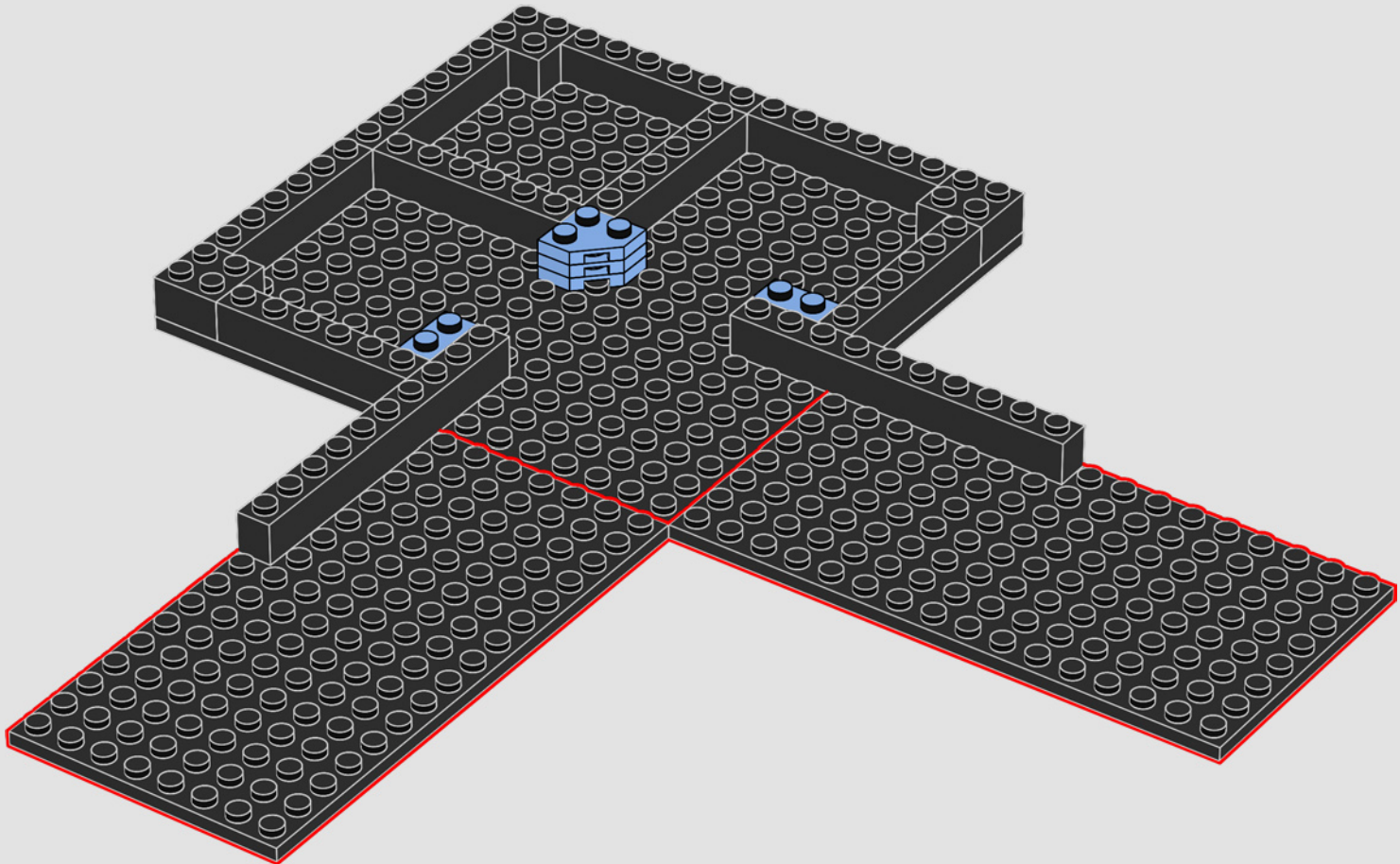
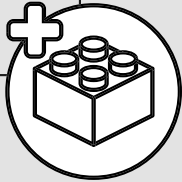

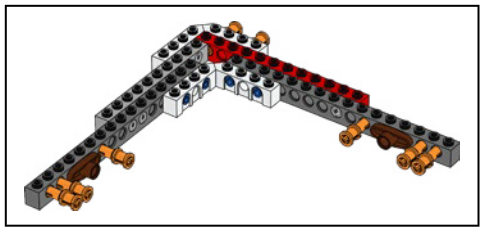

1

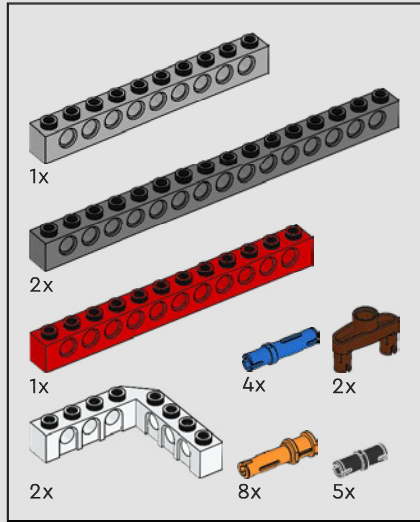
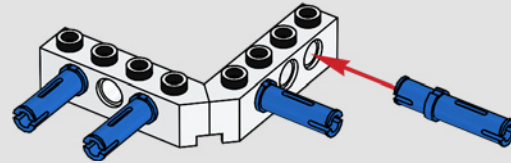

7

2

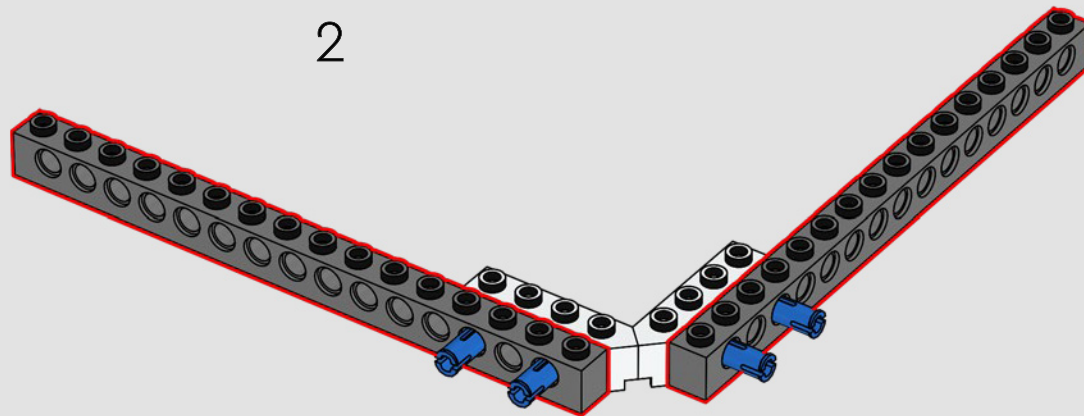

3

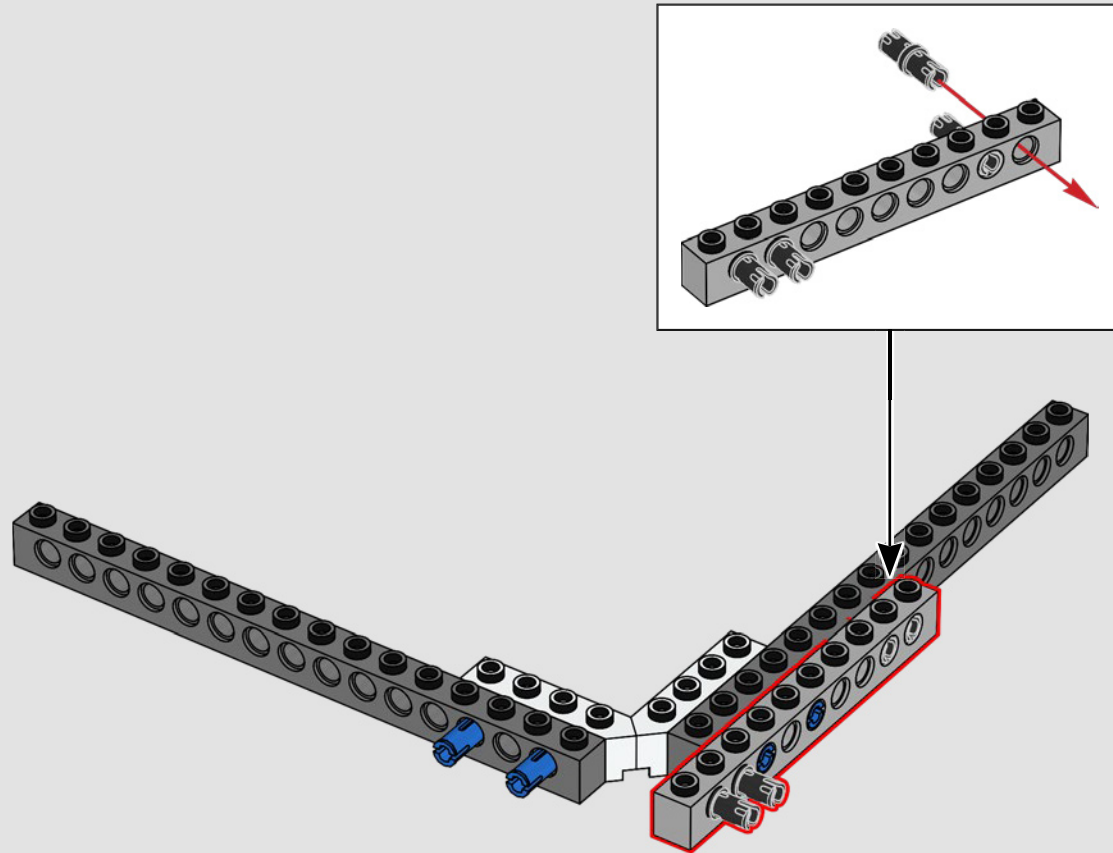

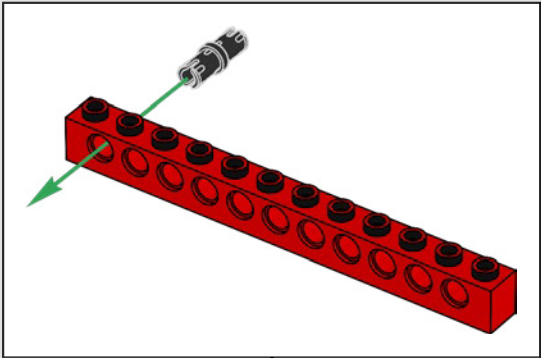

4

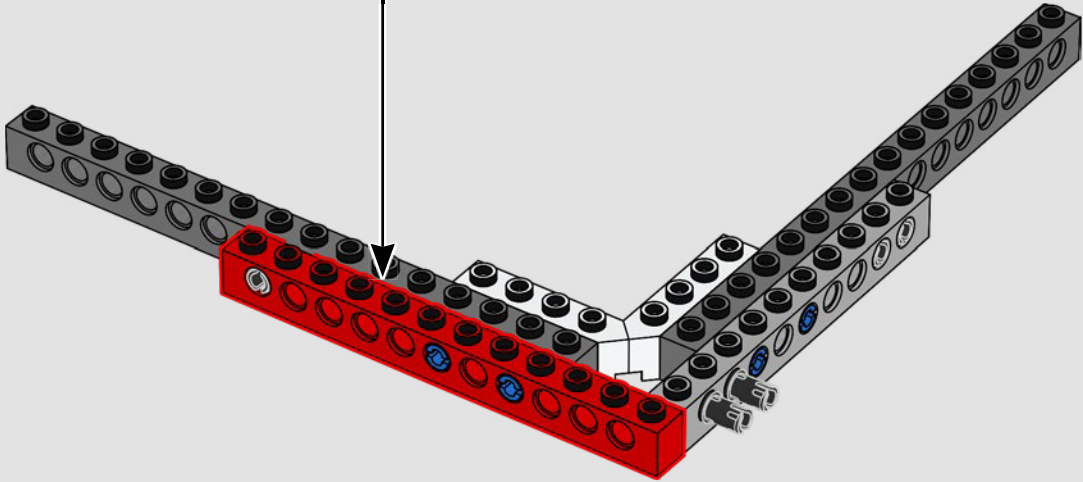

5

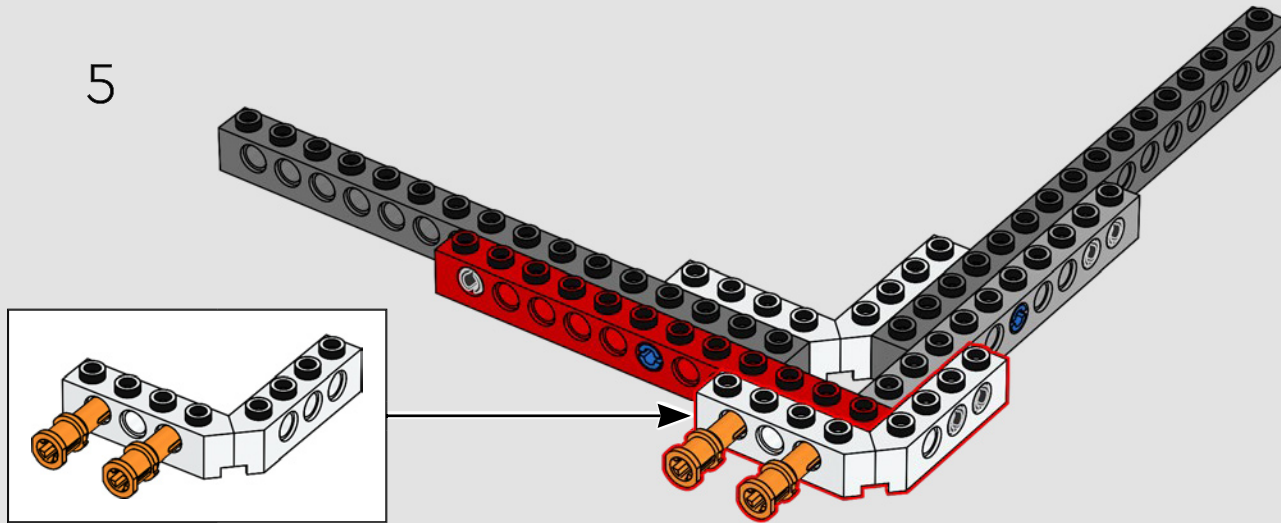

6

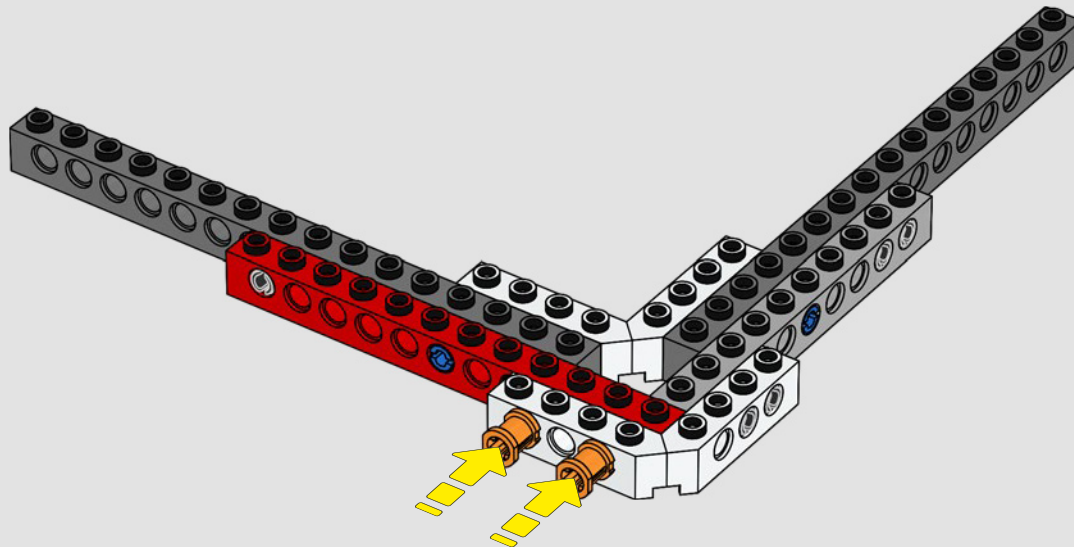



7

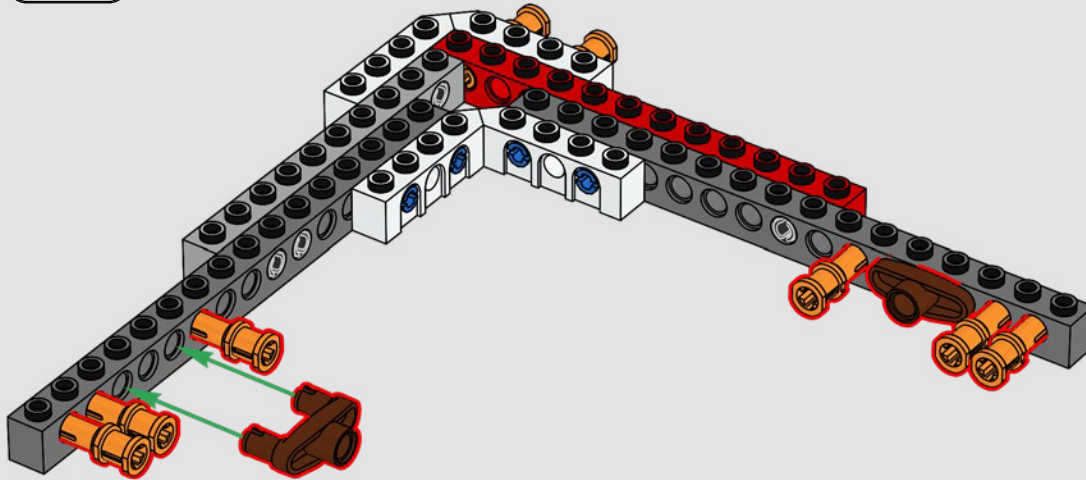

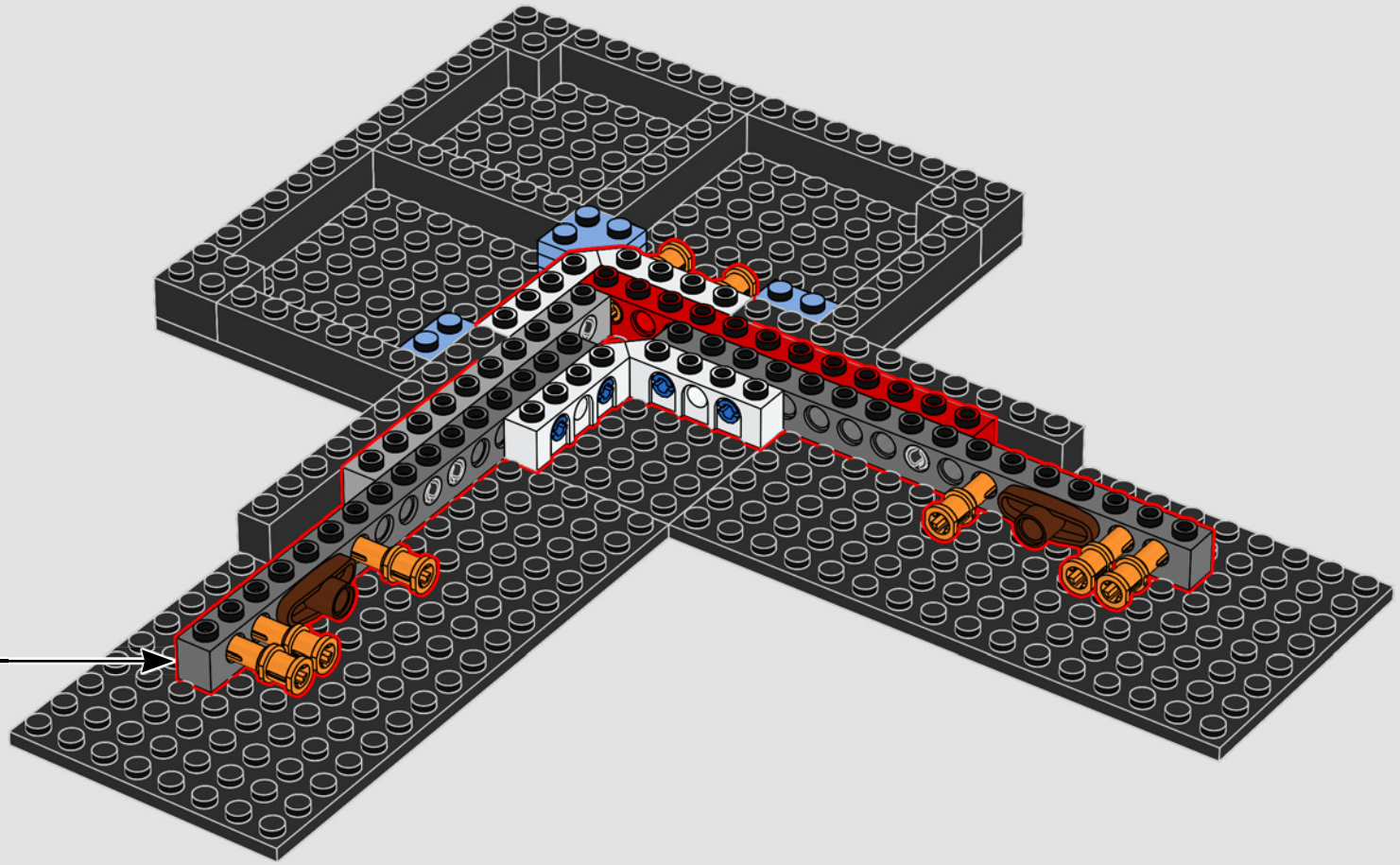



2x

8

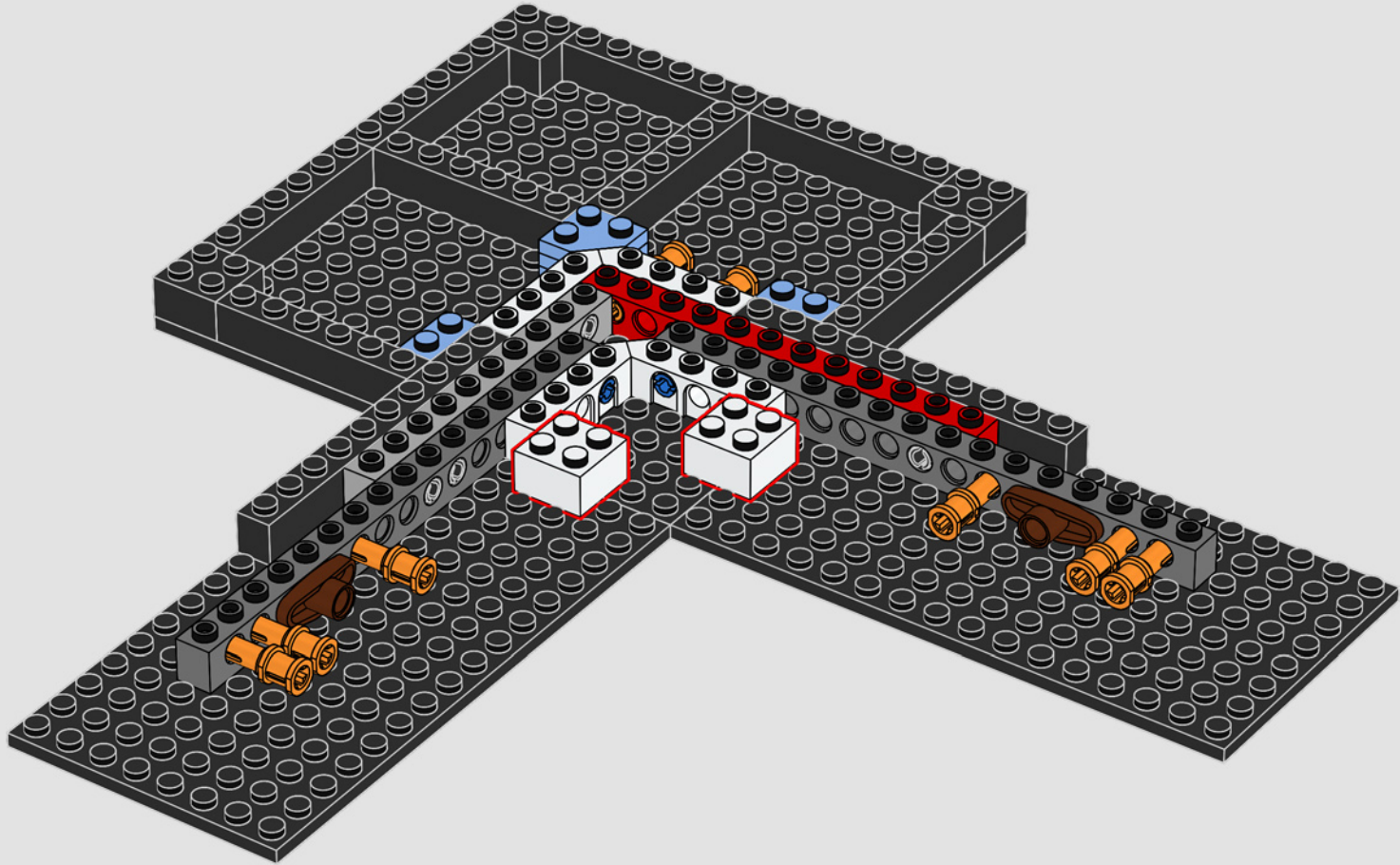

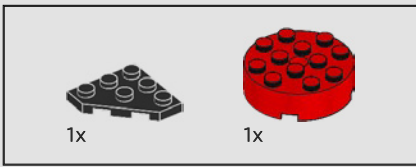

9

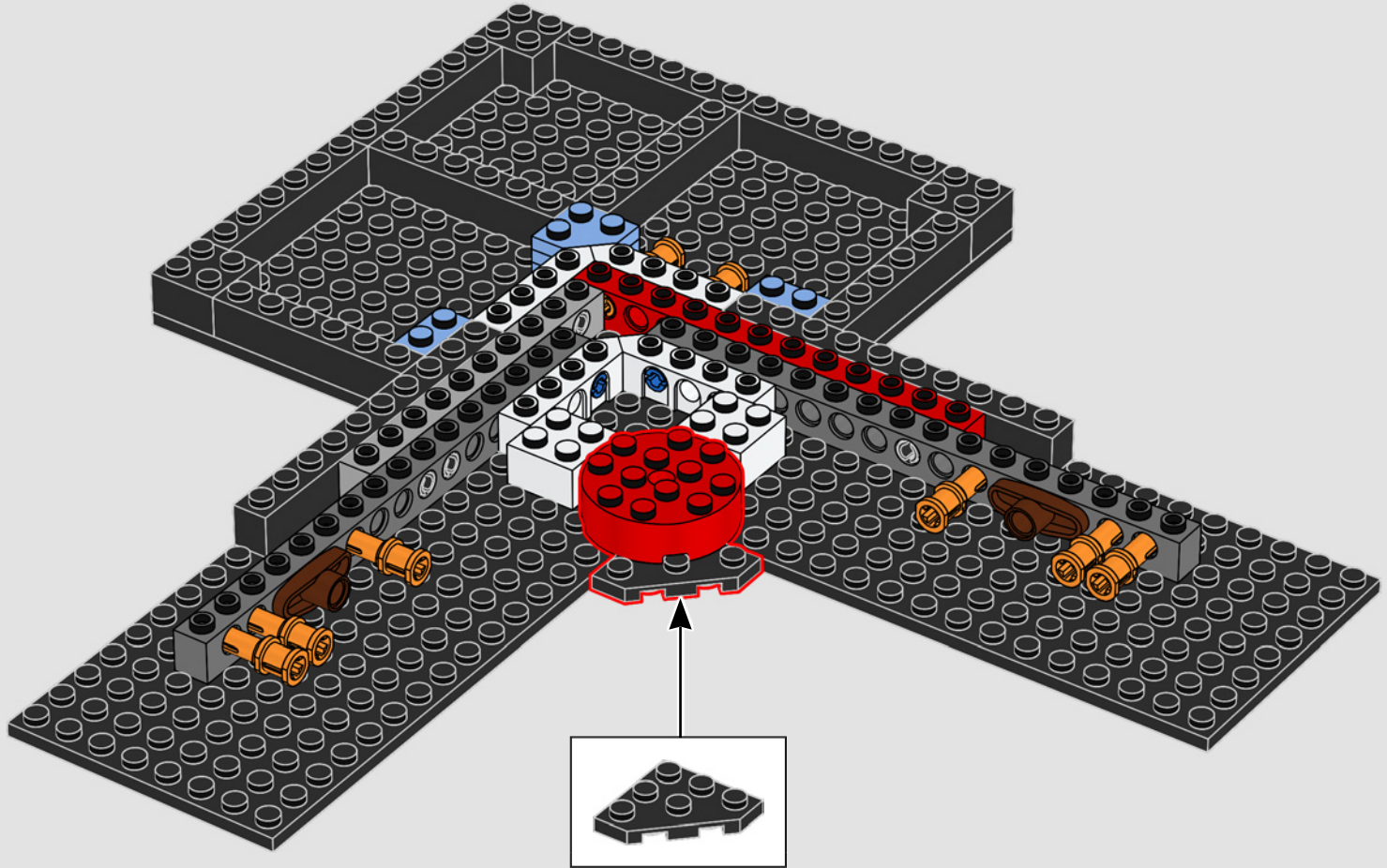

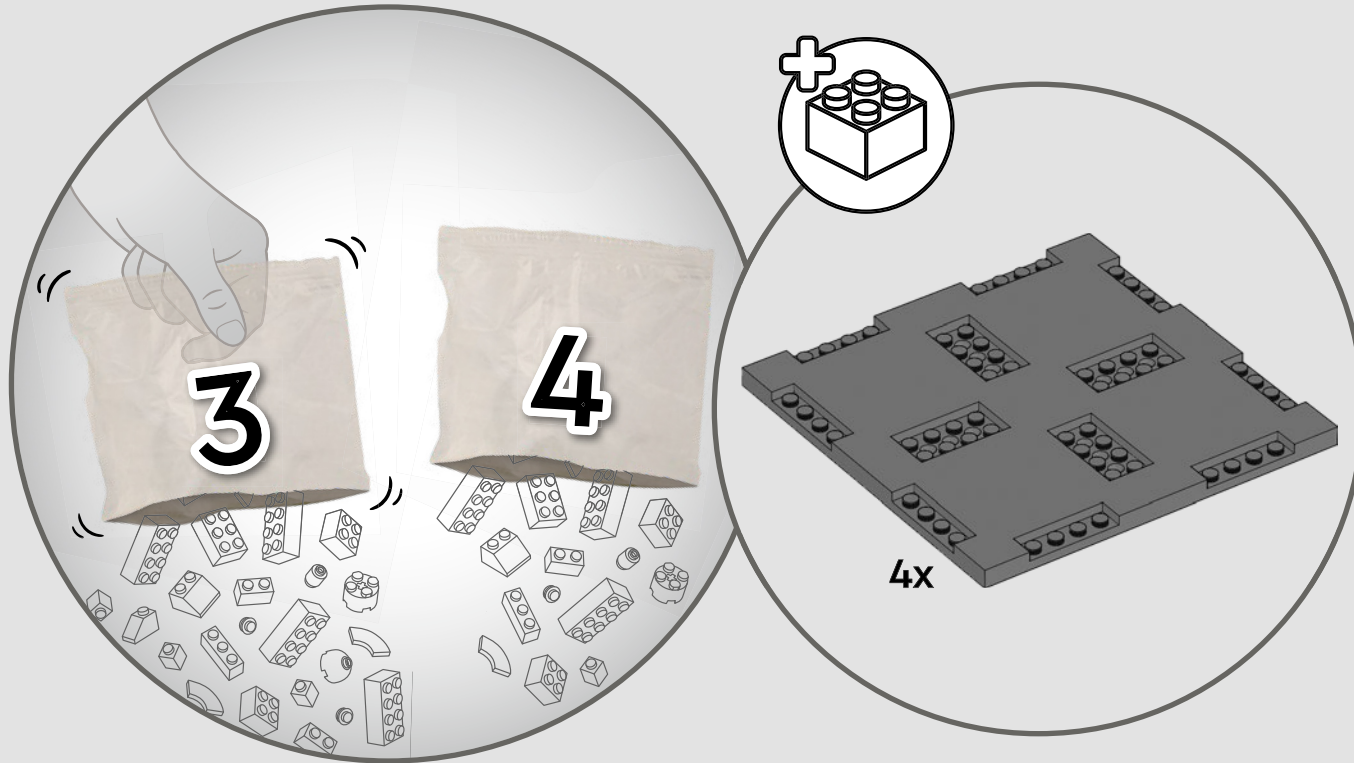

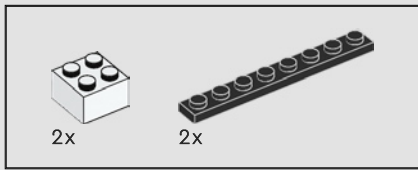

10

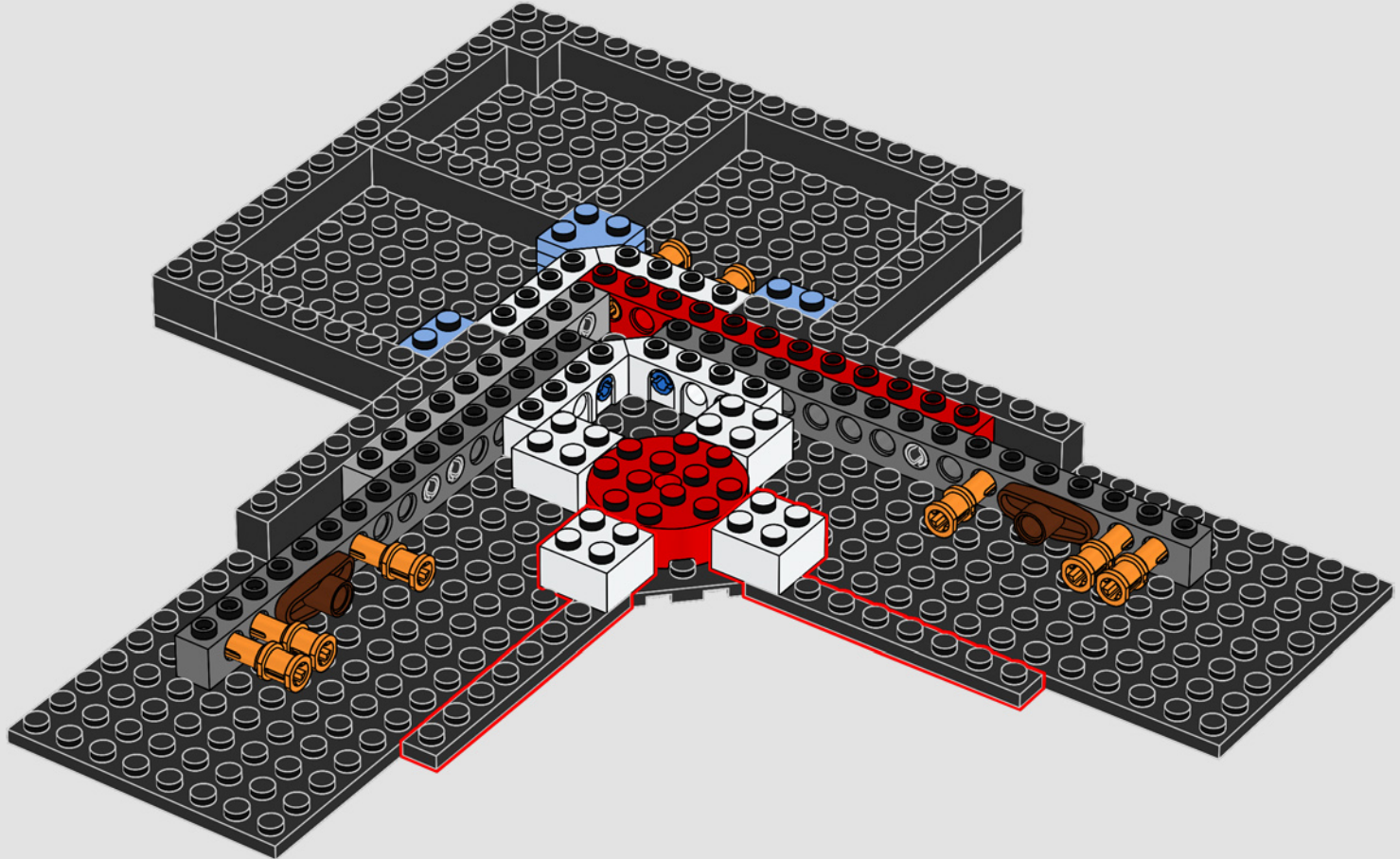

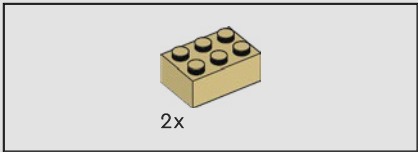

11

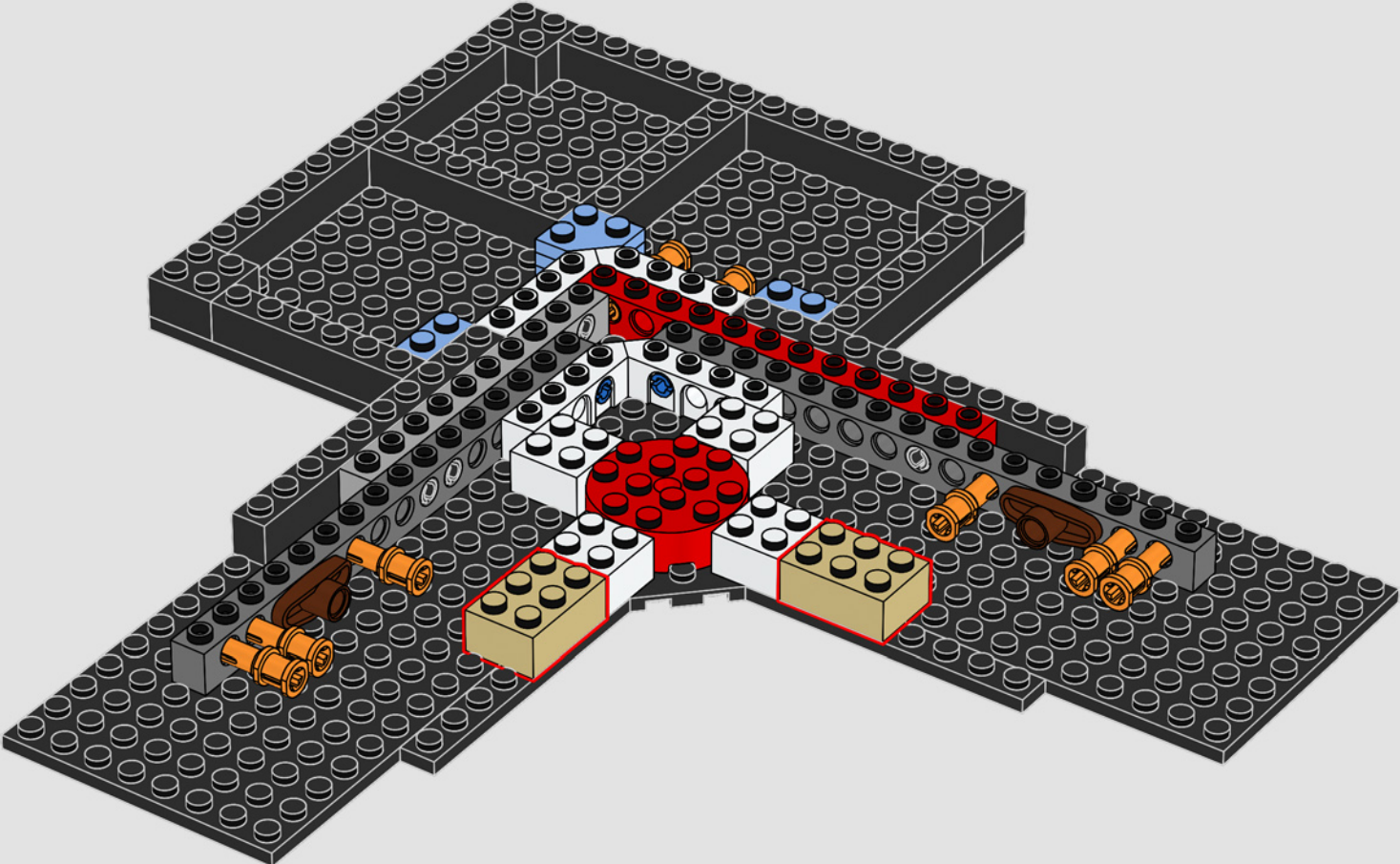

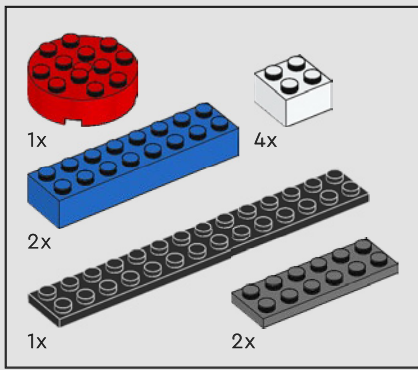

12

1

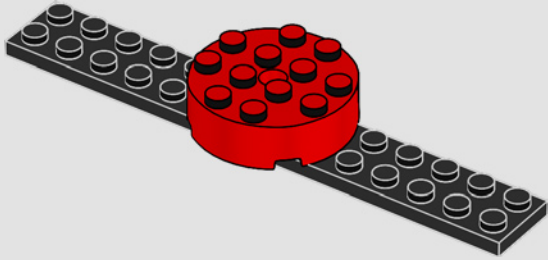

2

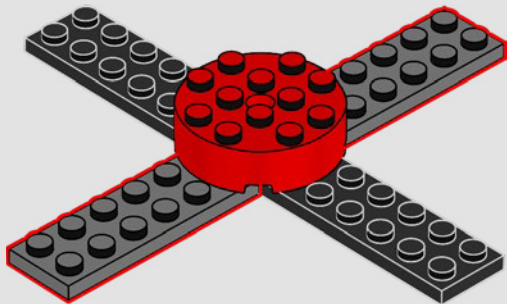

3

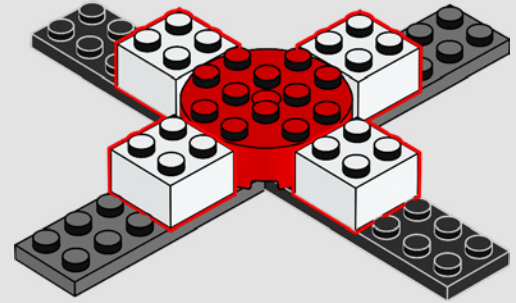

4

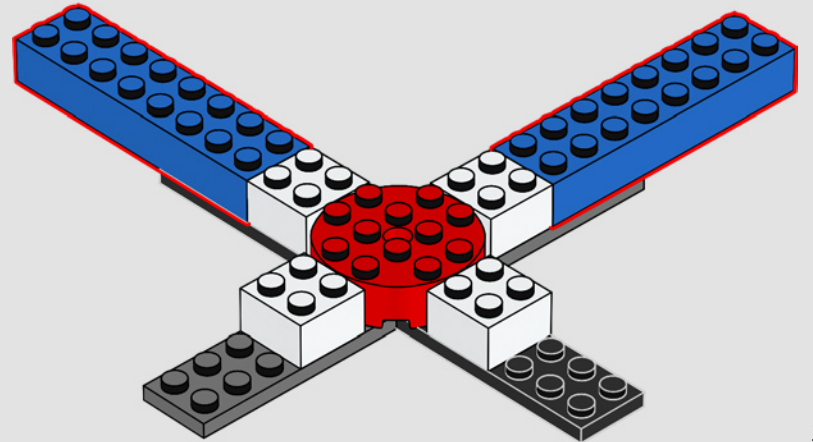

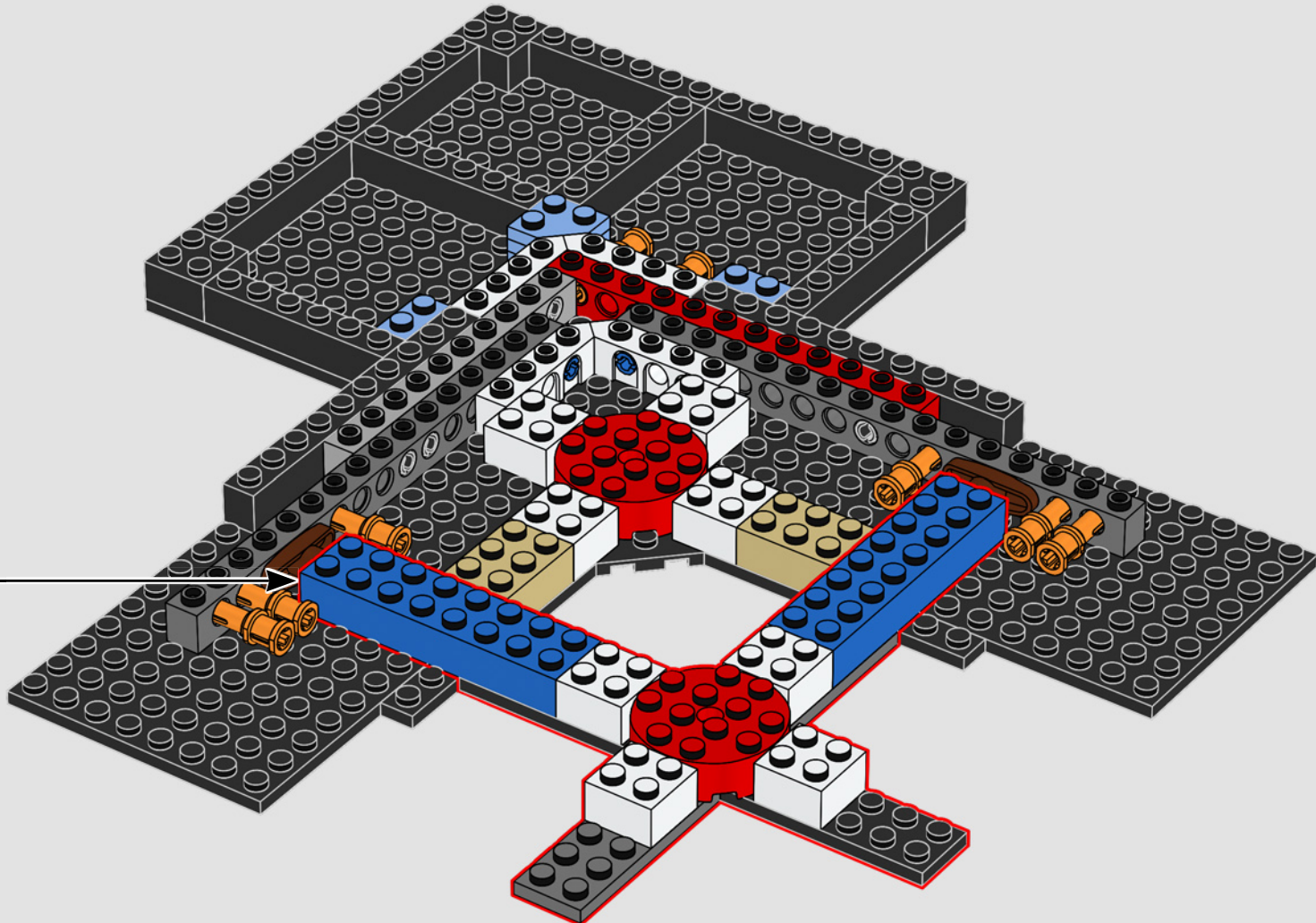

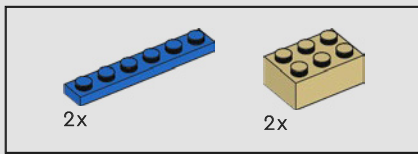

13

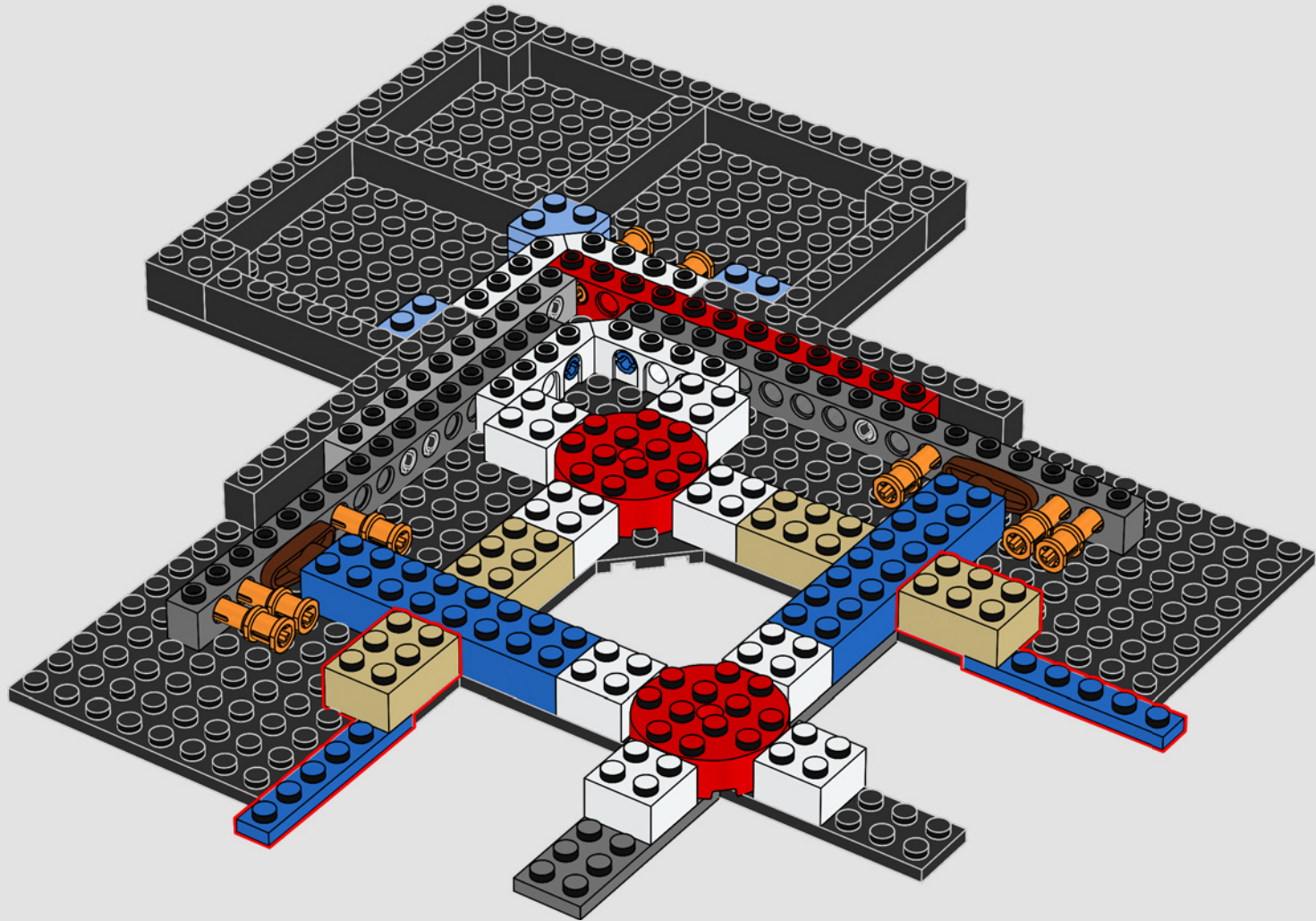

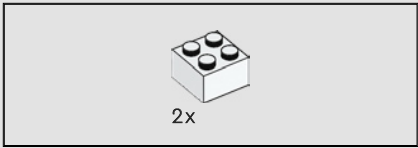

14

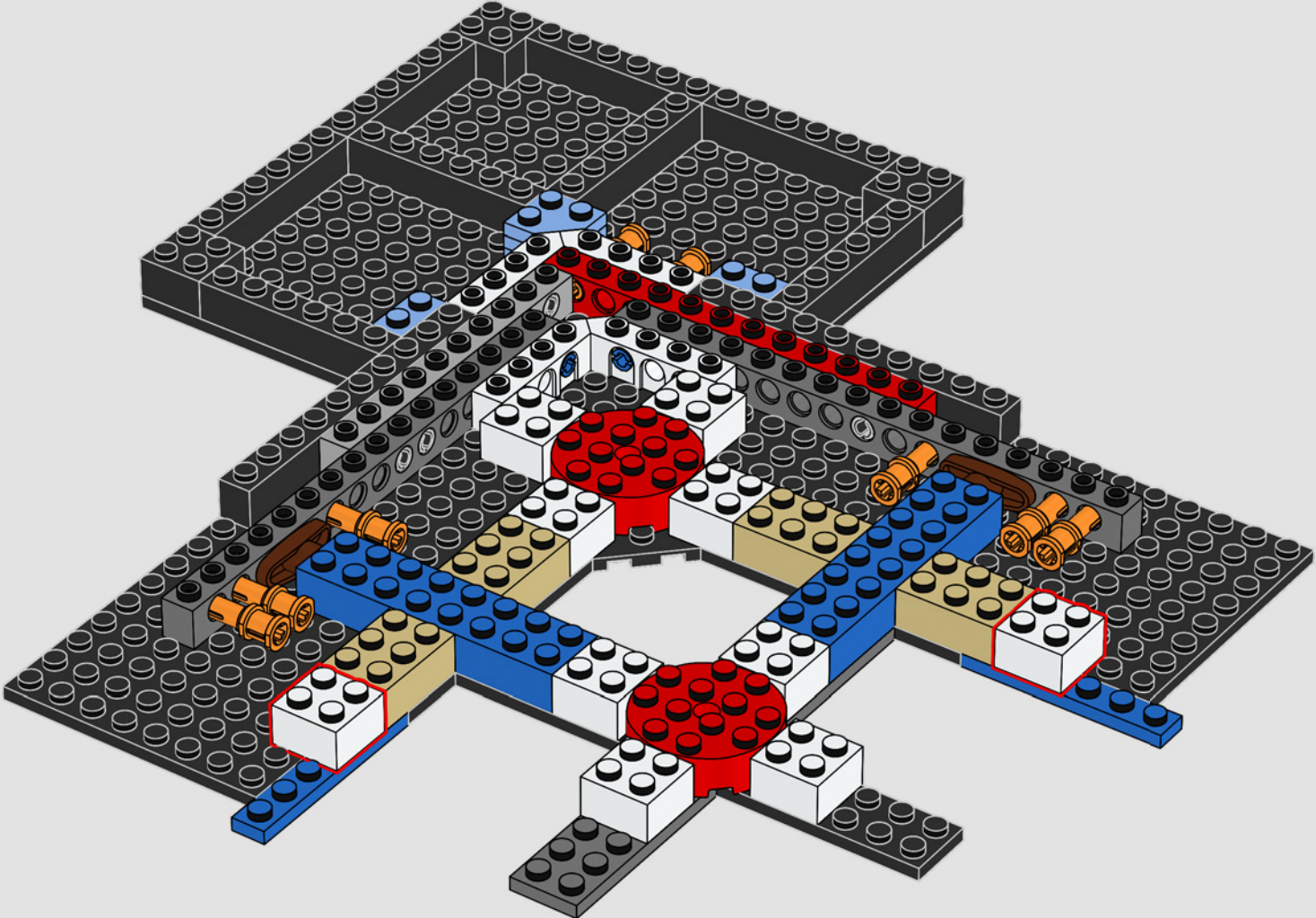

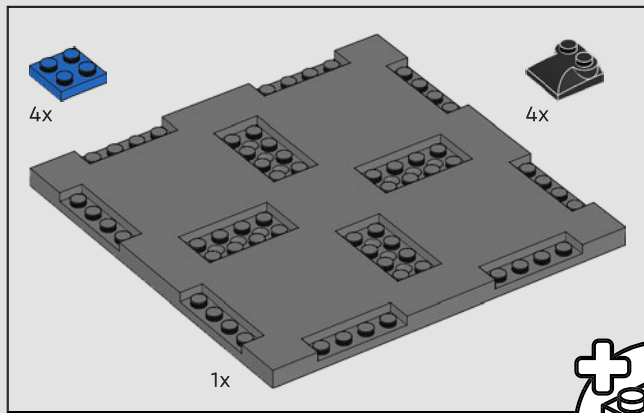

15

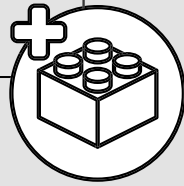

1

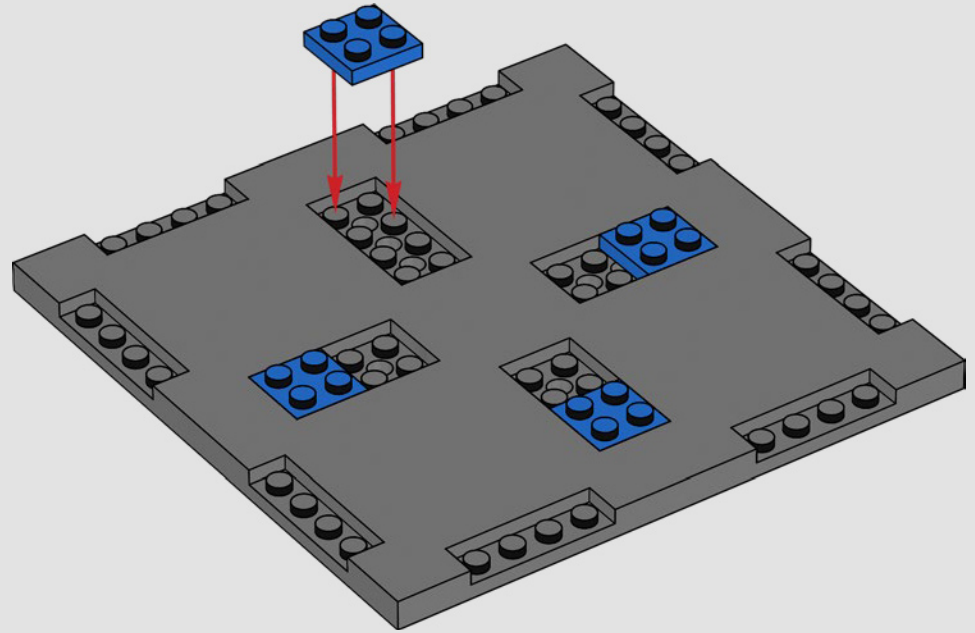

2

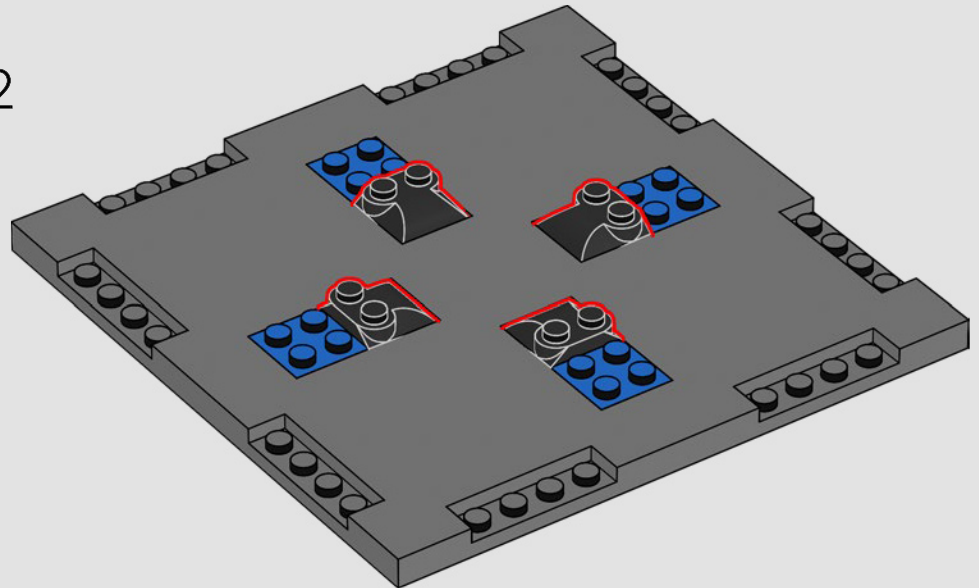

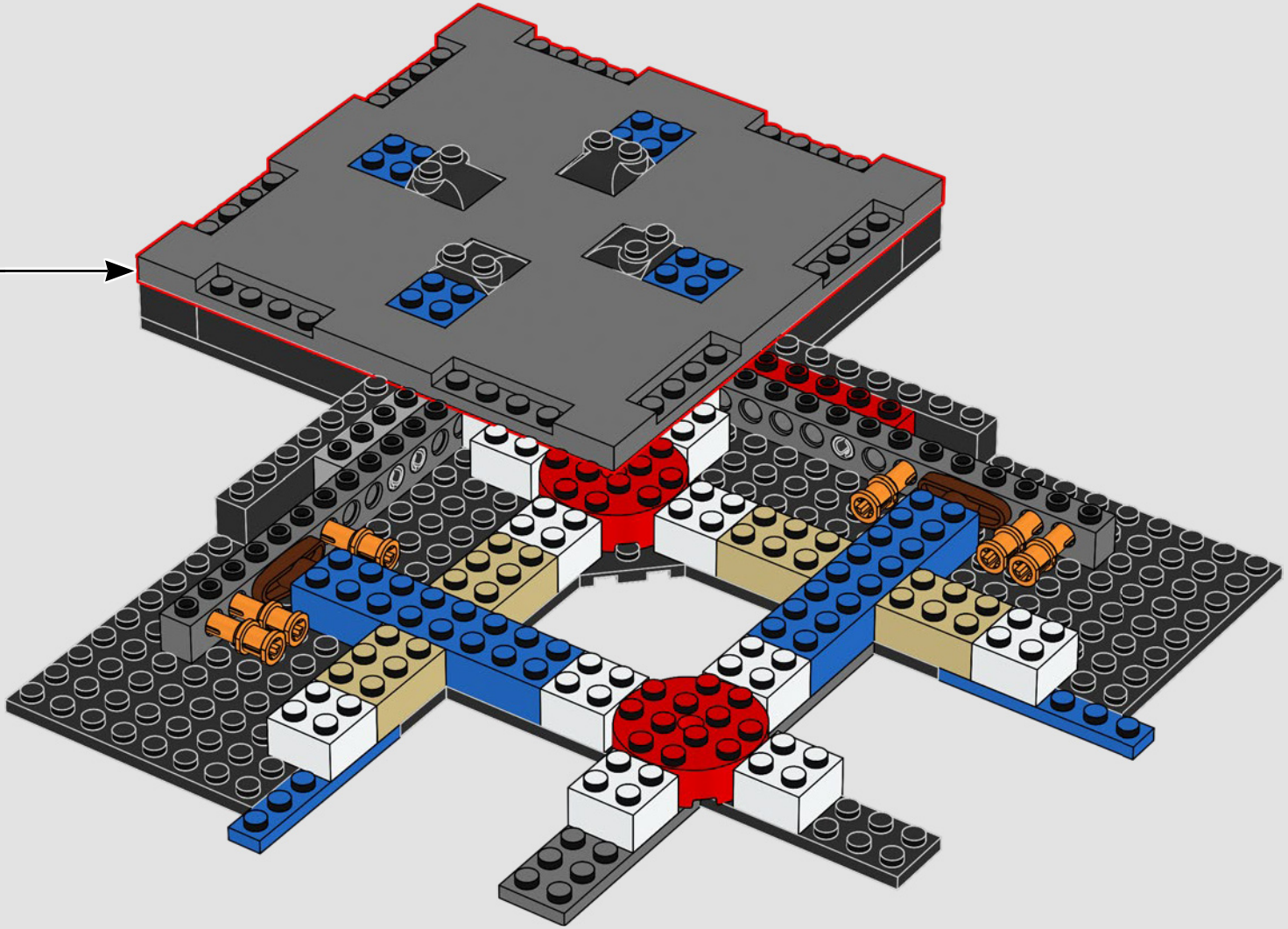

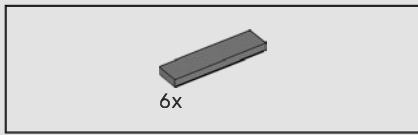

16

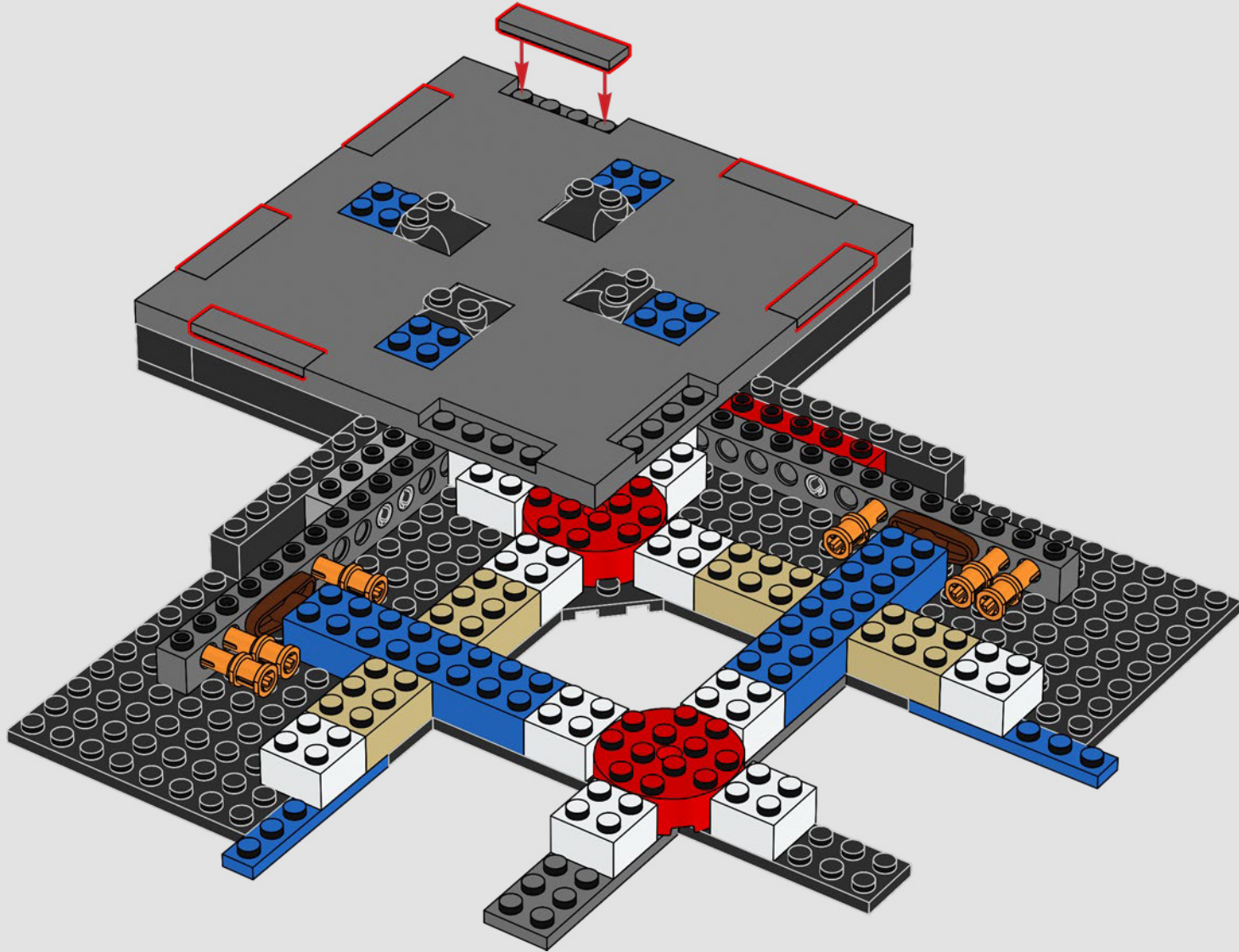

4x

17

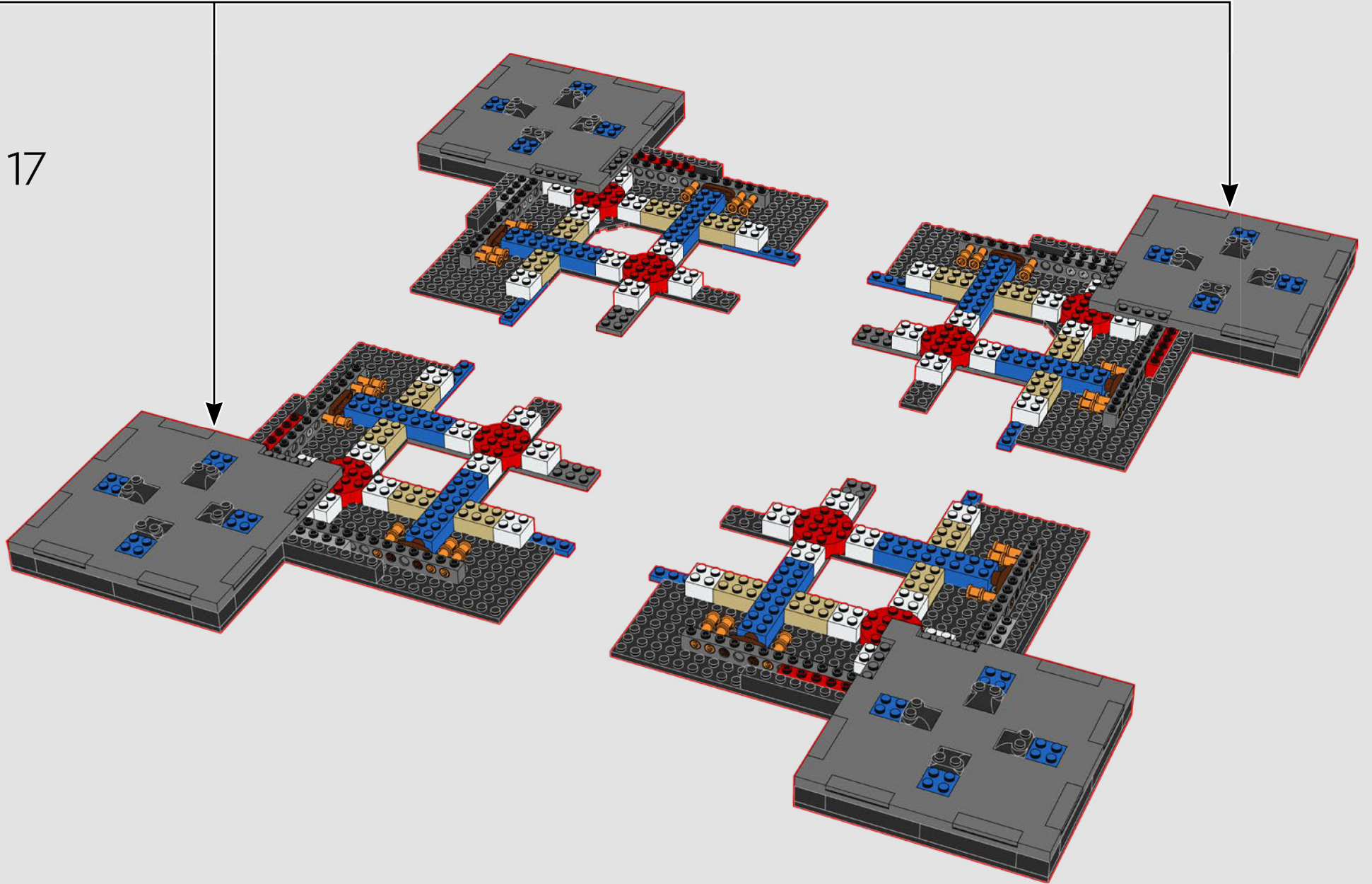



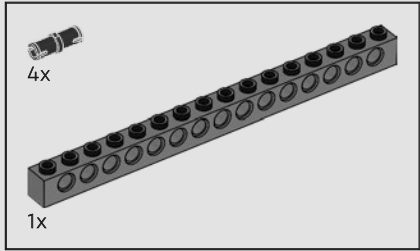
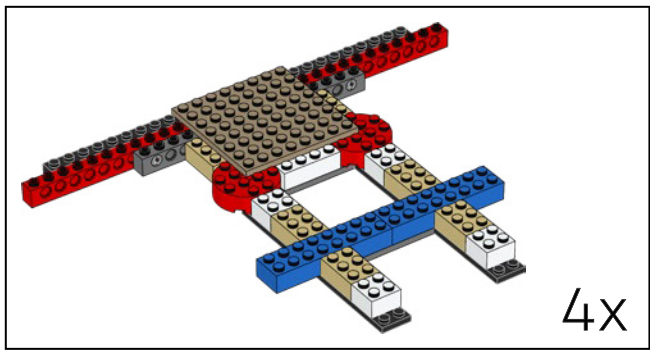

18

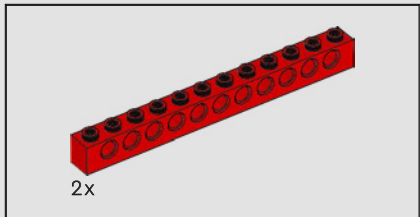
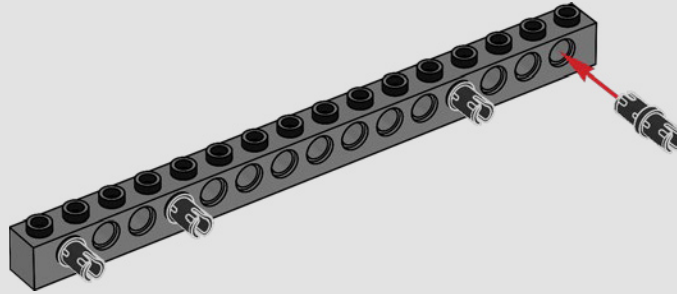

19

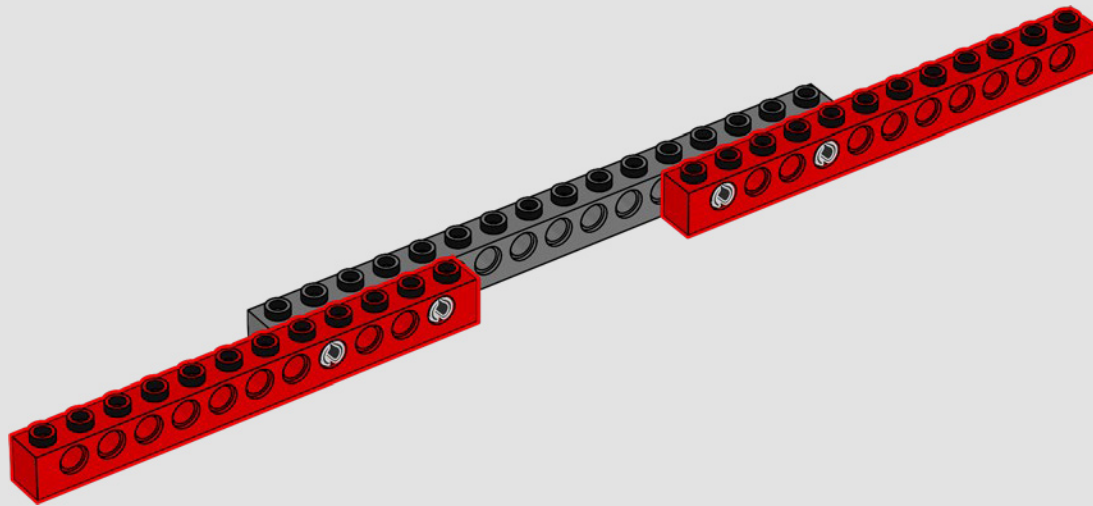

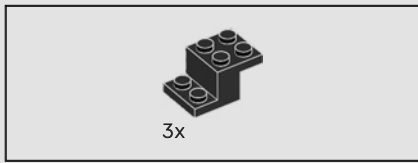

20

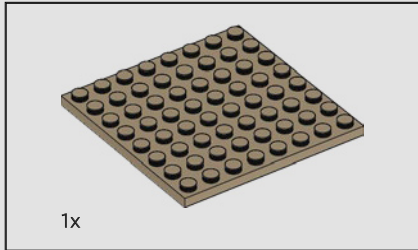
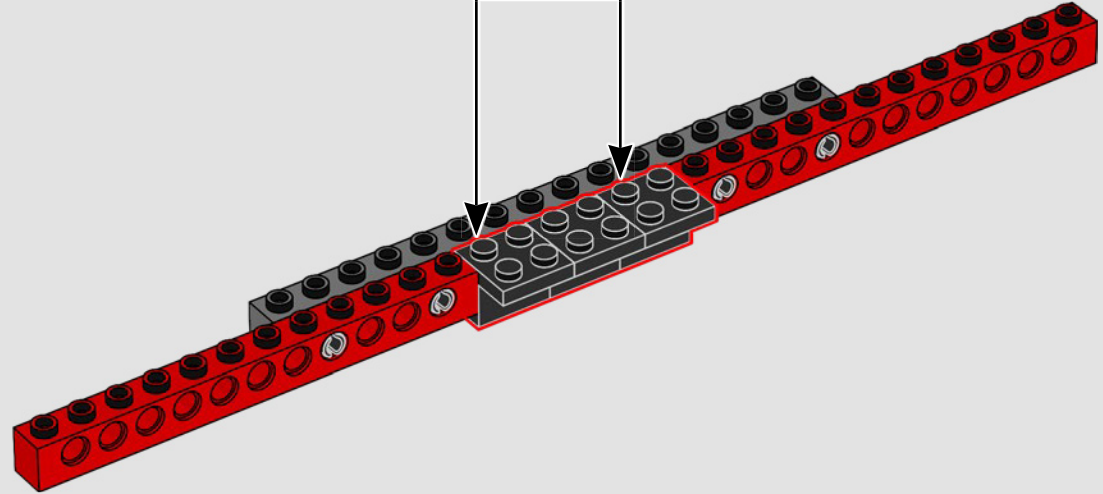
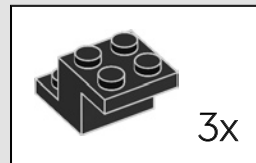

21

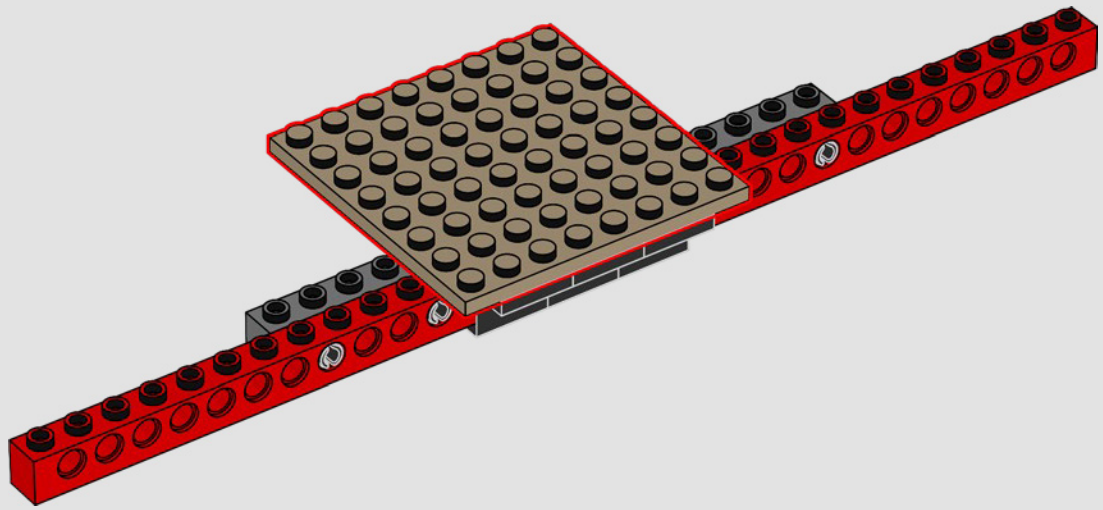



22

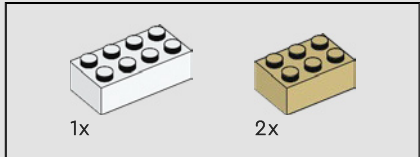
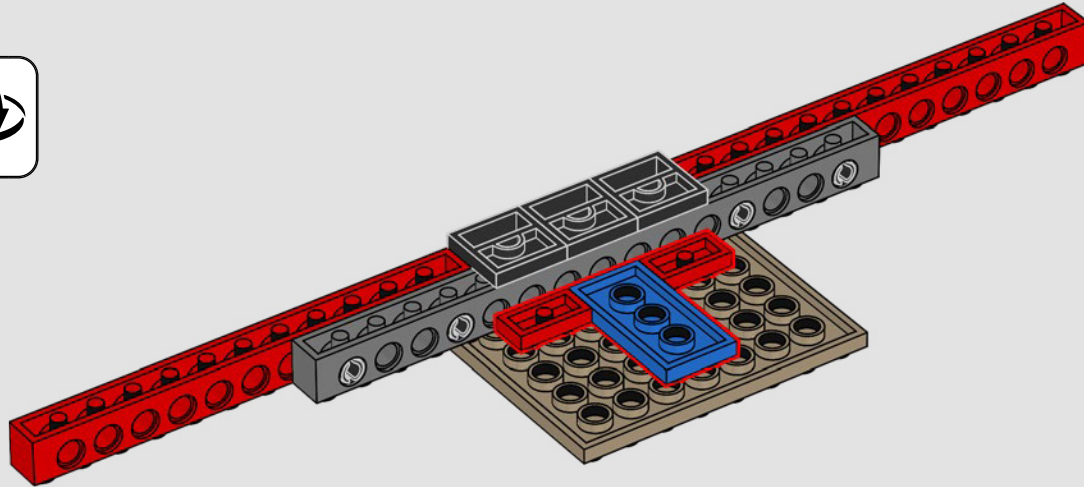

23

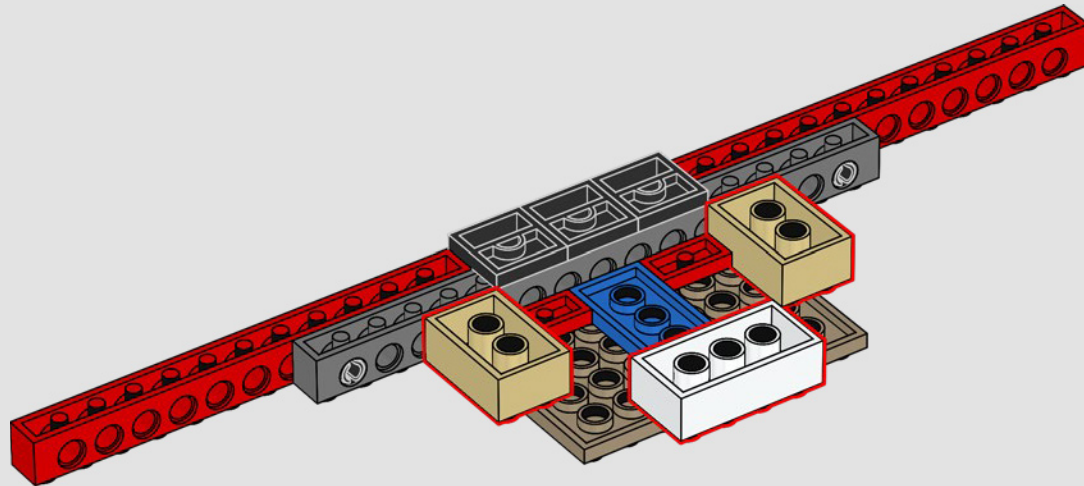



24

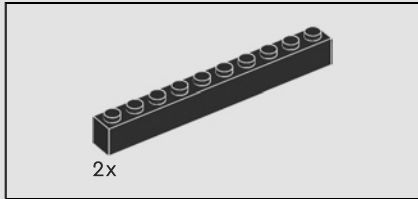
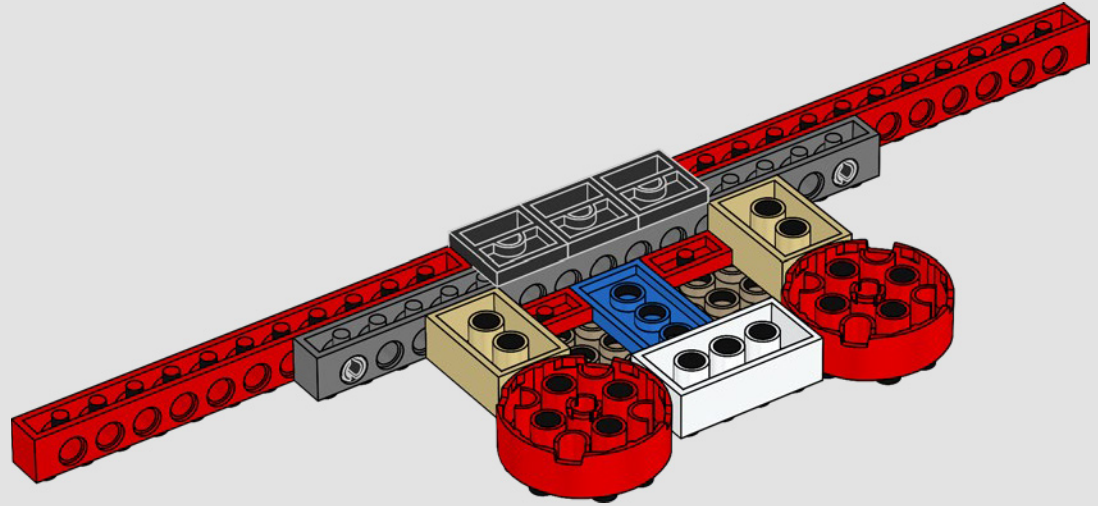

25

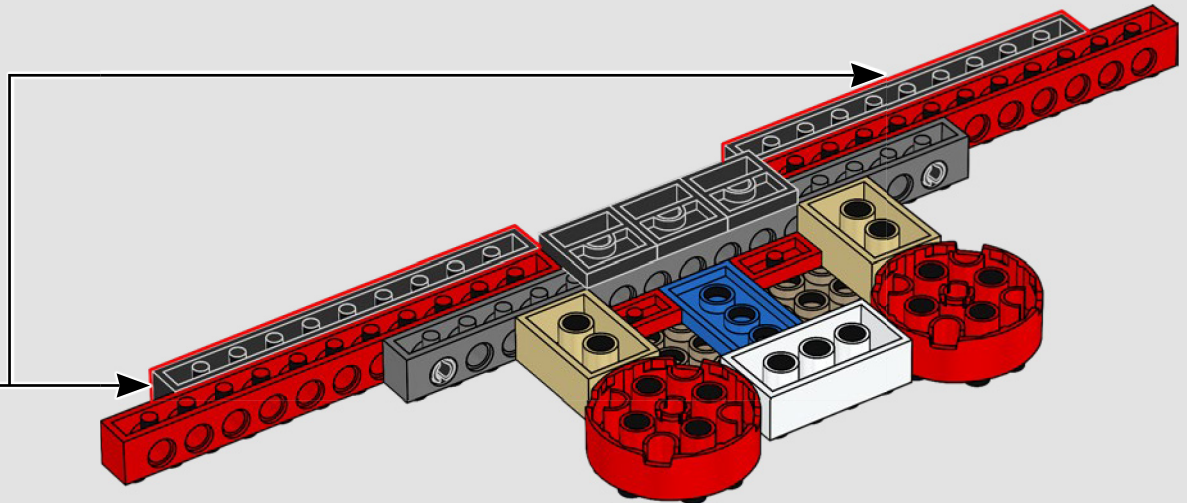
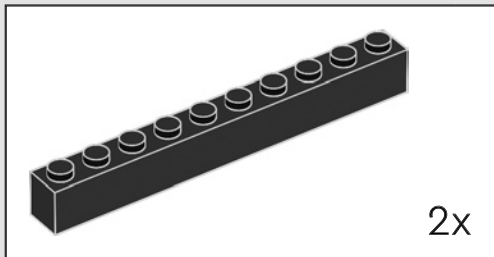

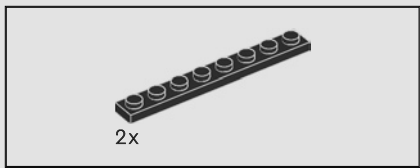

26

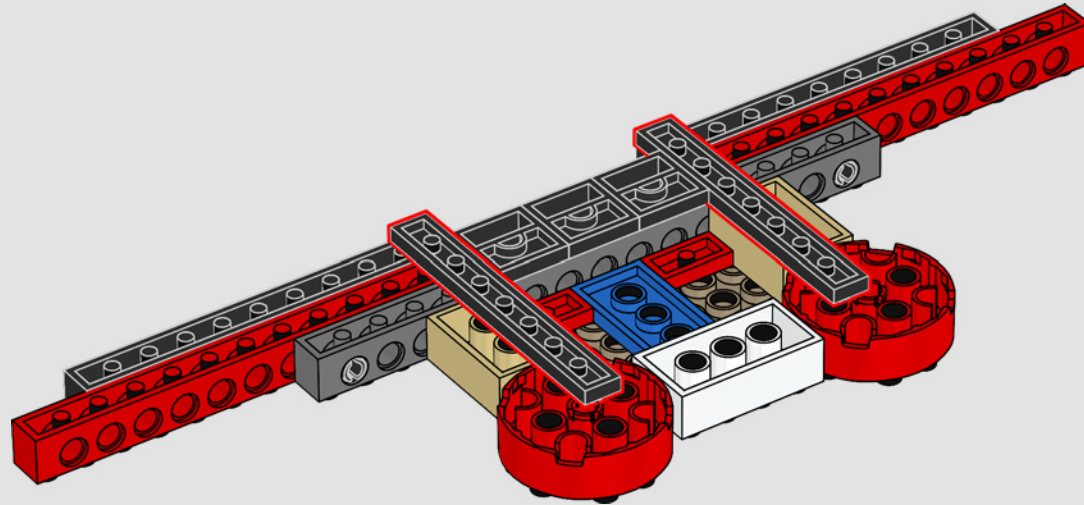

27

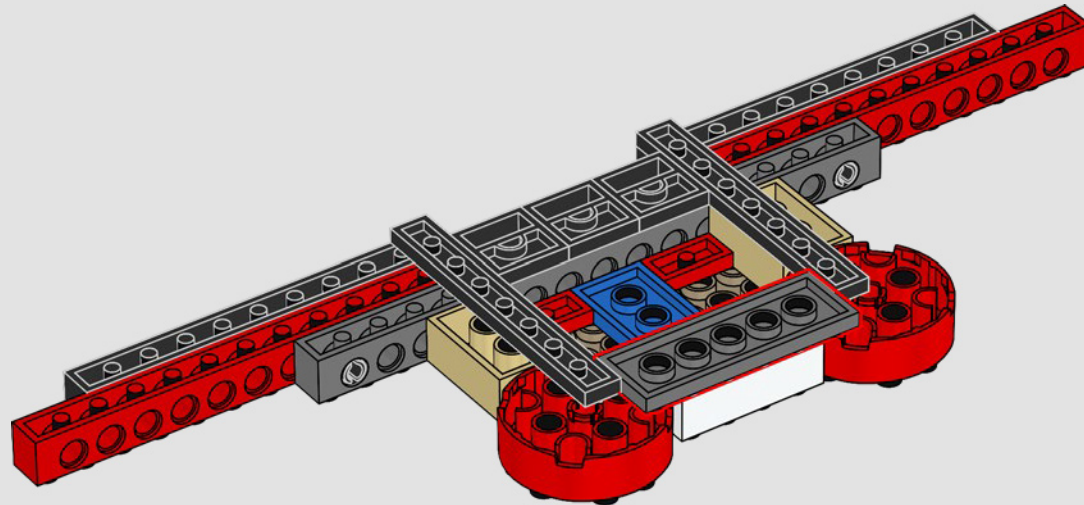

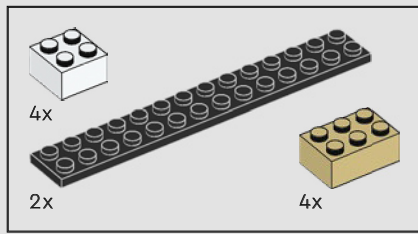

28

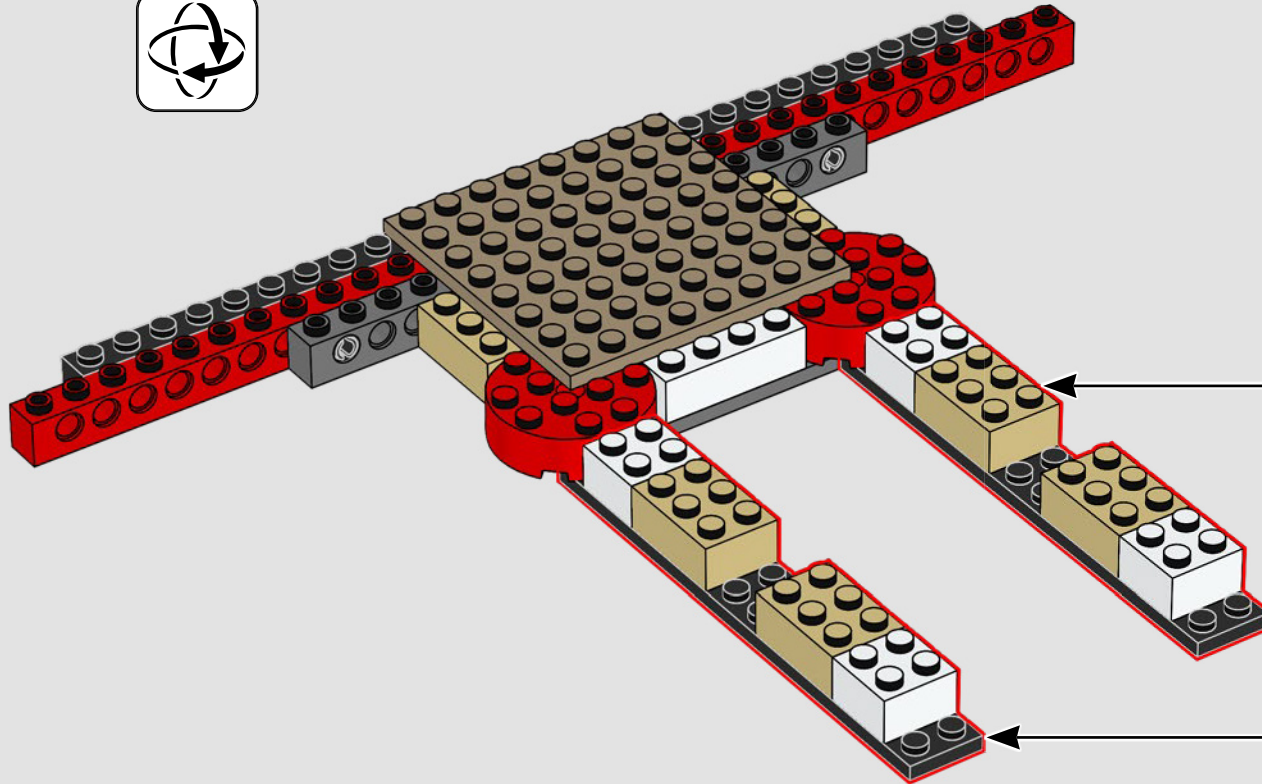
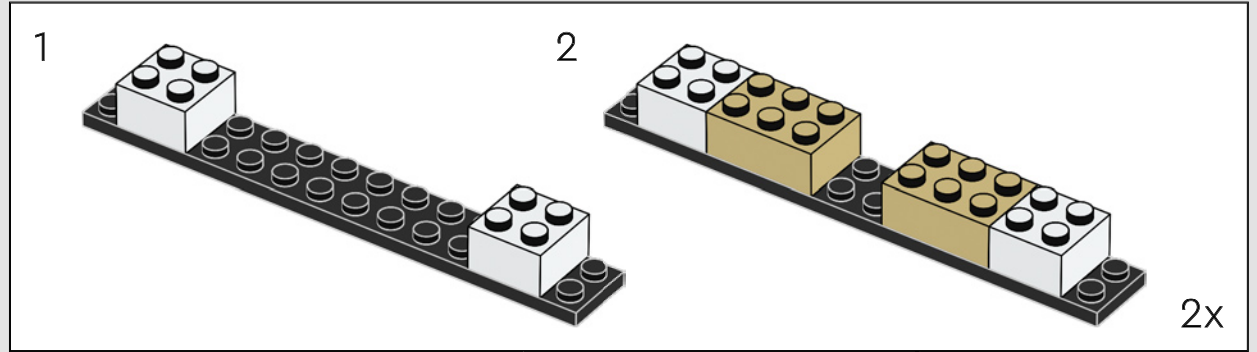

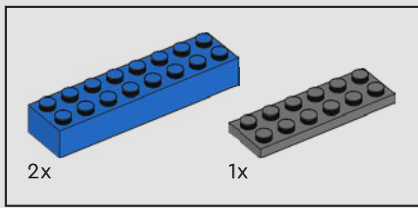

29

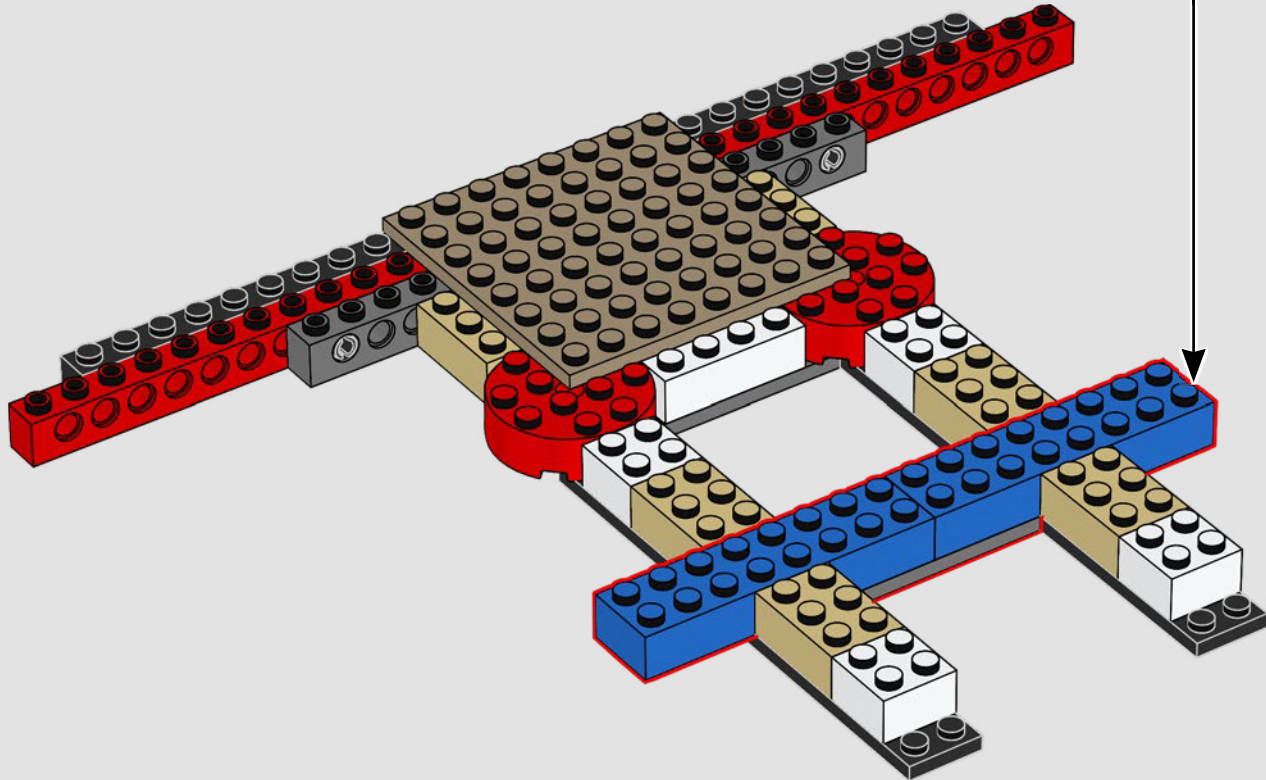
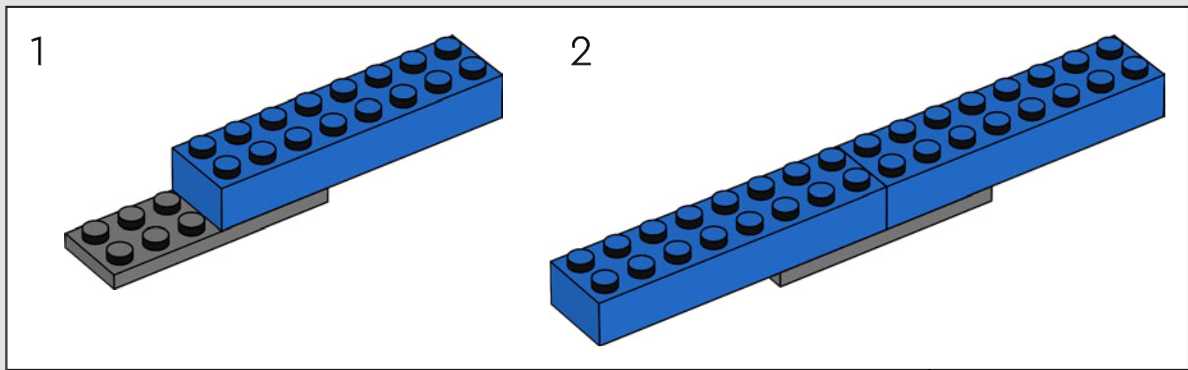

4x

30

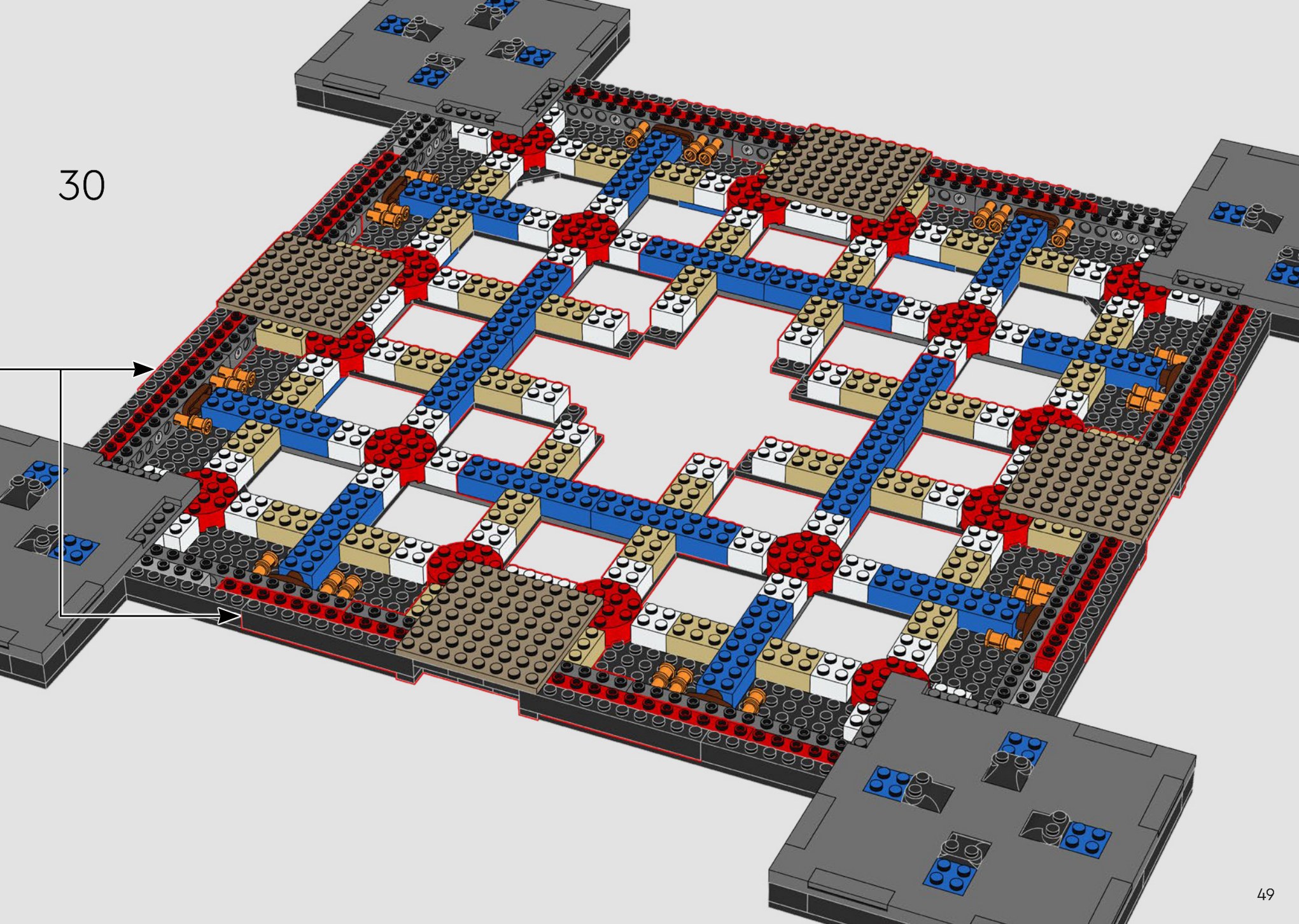

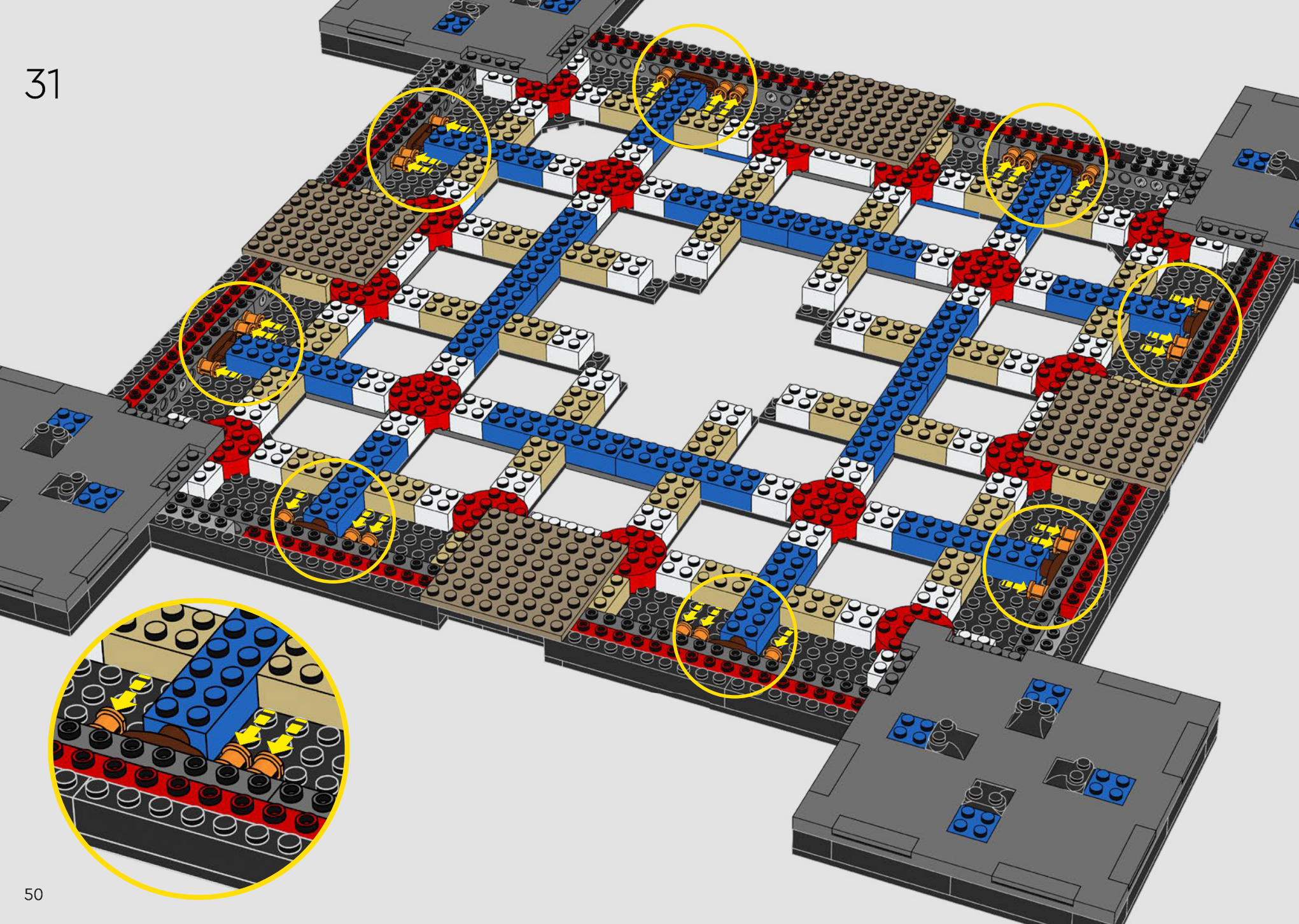

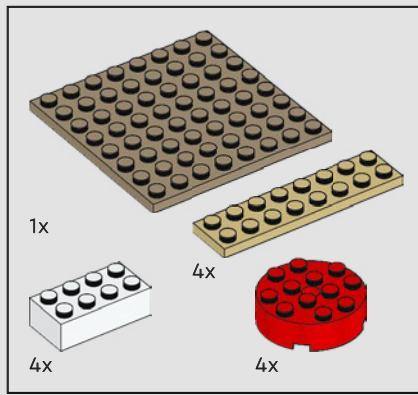

32

1

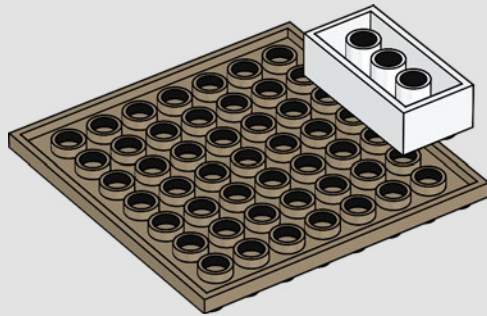

2

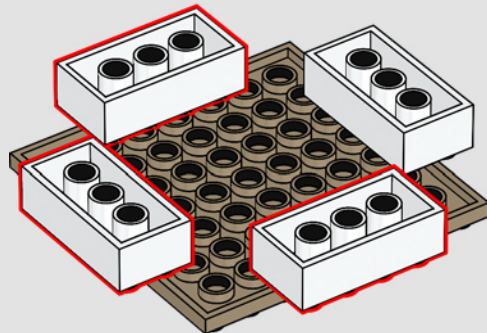

3

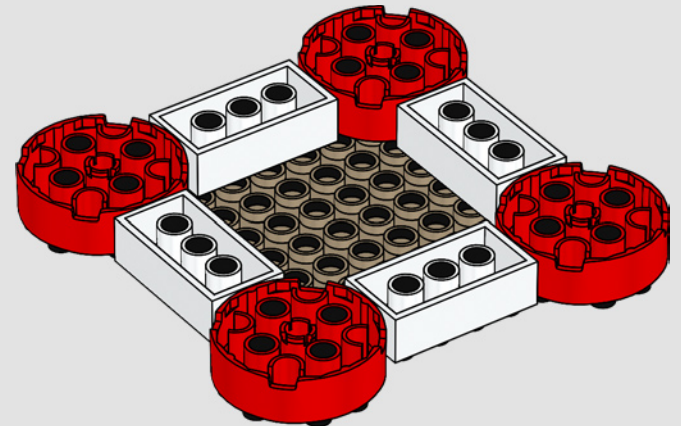

4

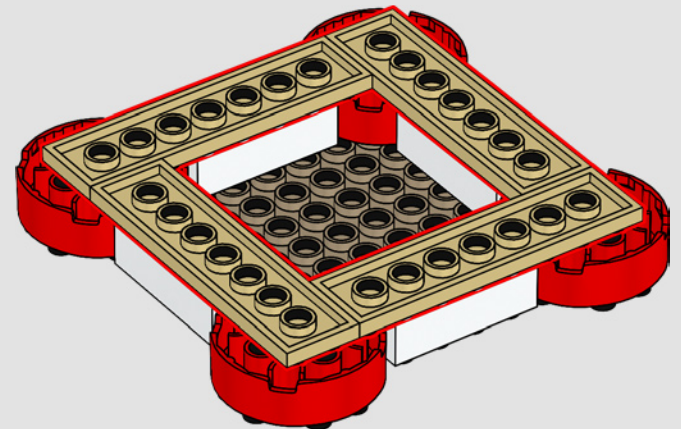

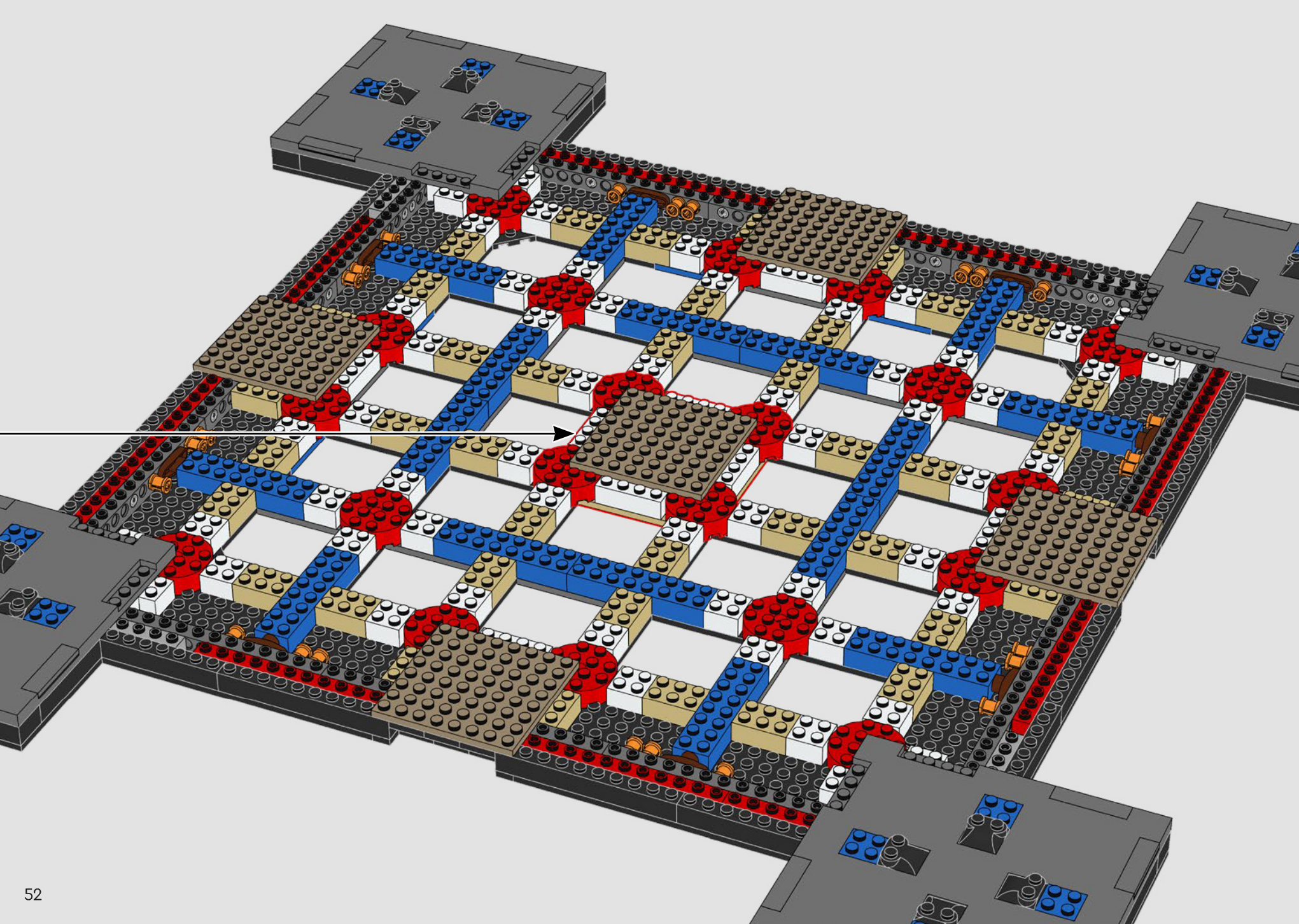

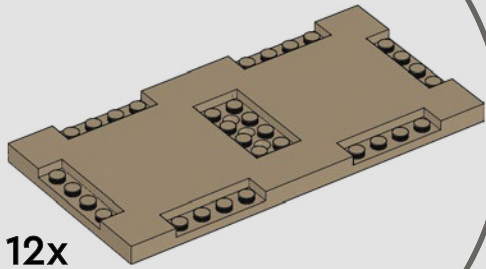
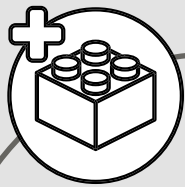

12x

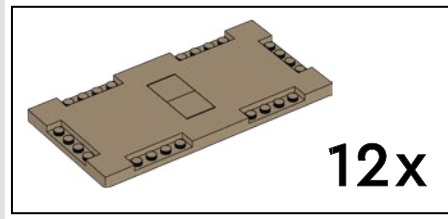

12x

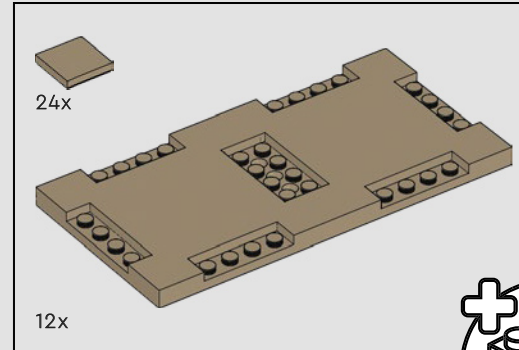

12x

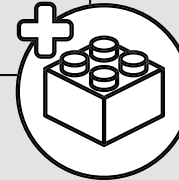

33

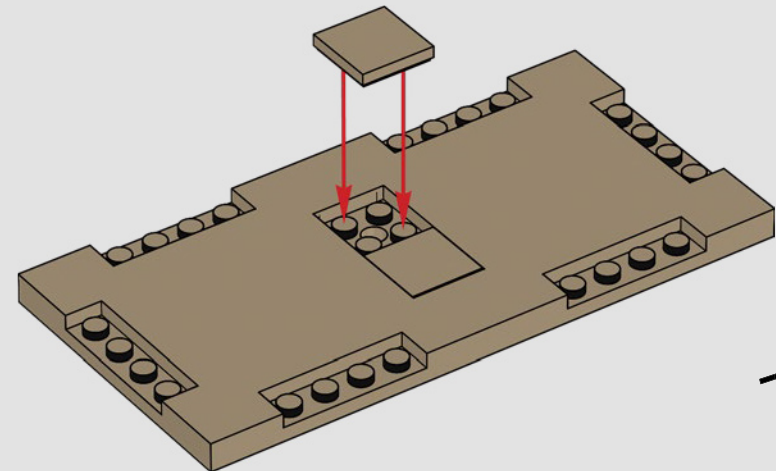
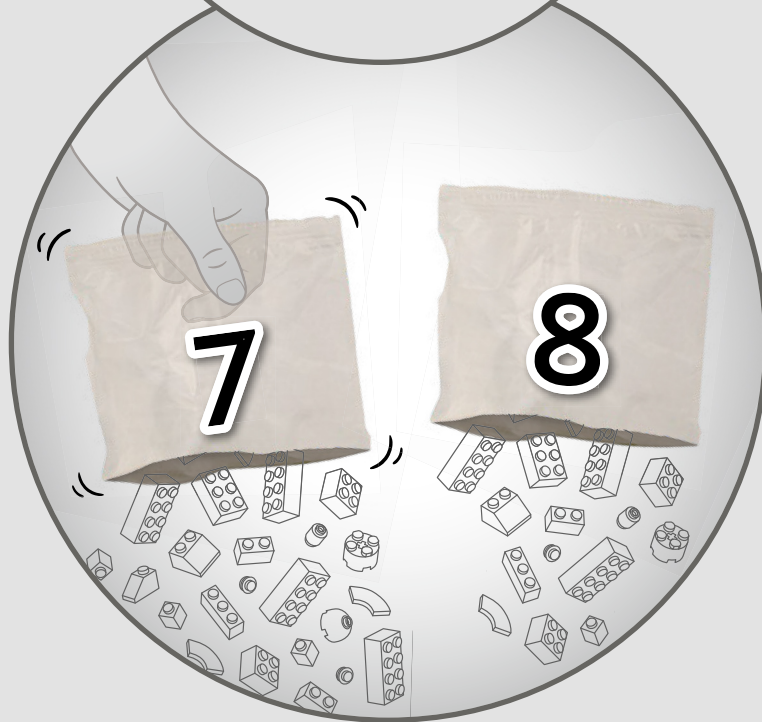

12x

34

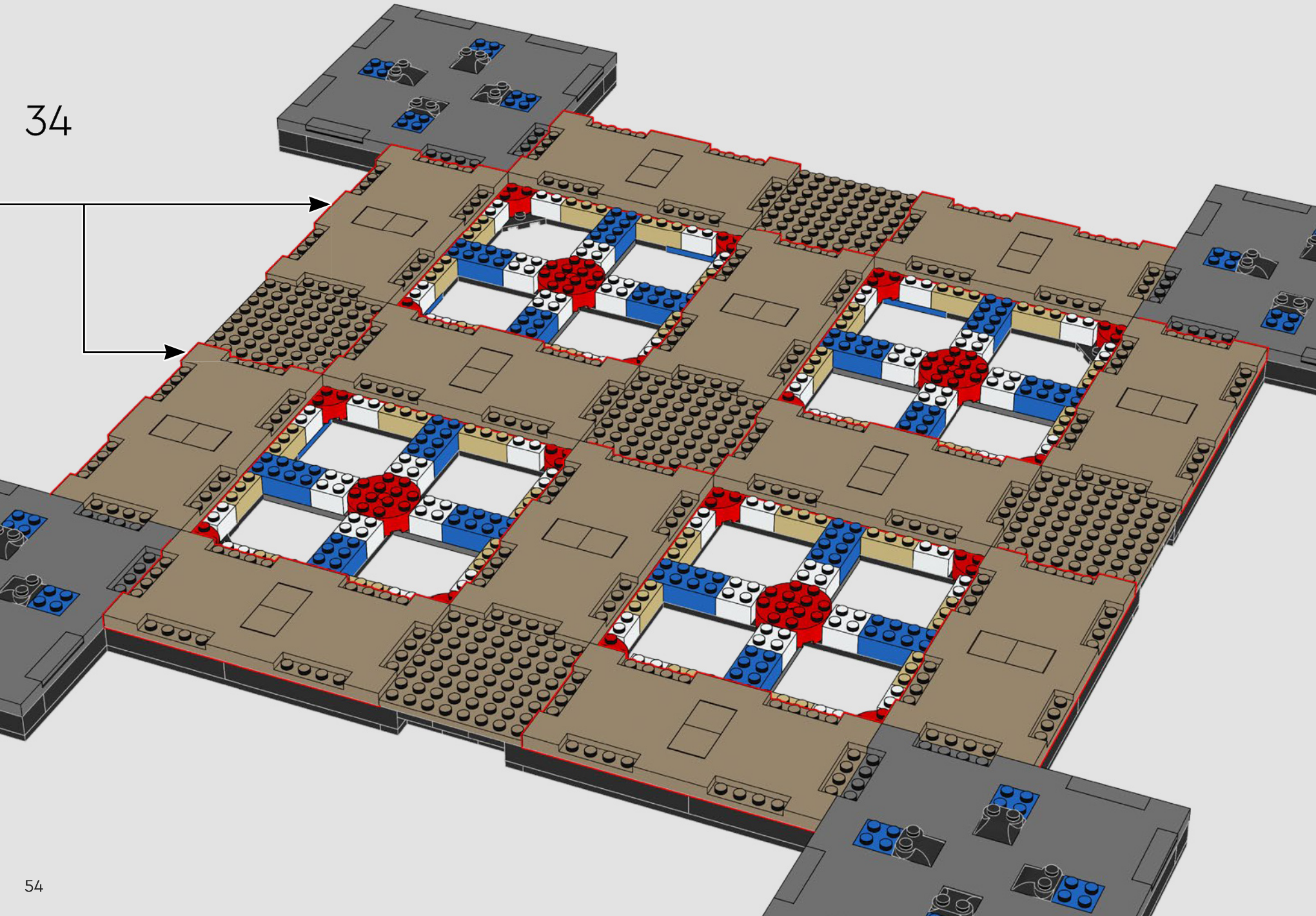

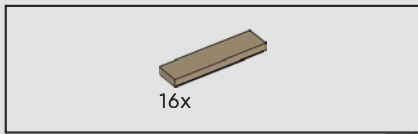

35

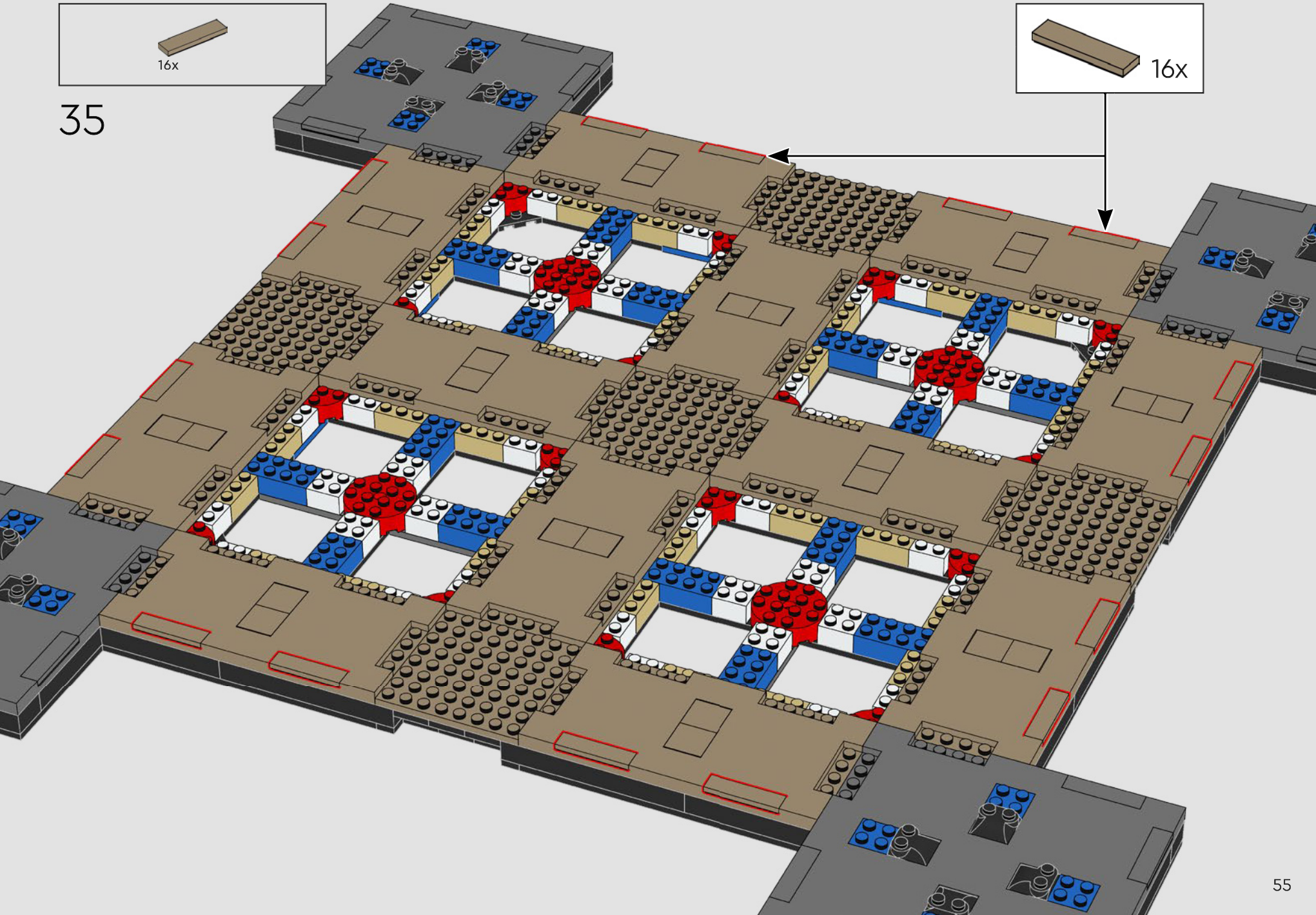
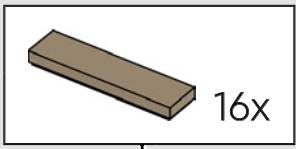

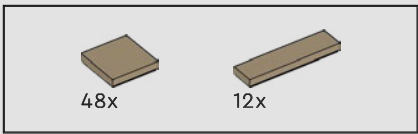

36

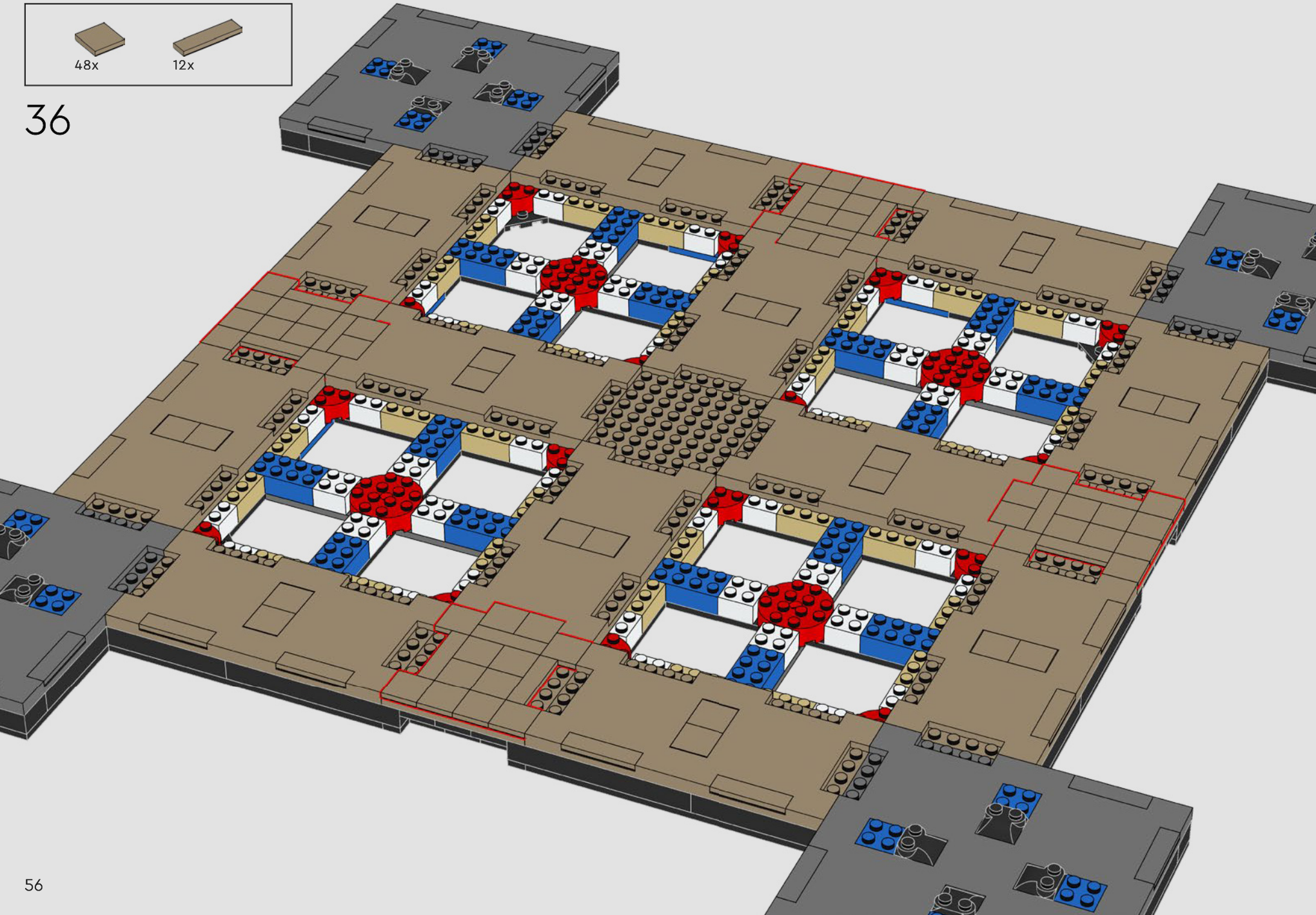

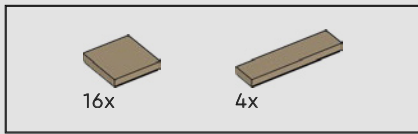

37

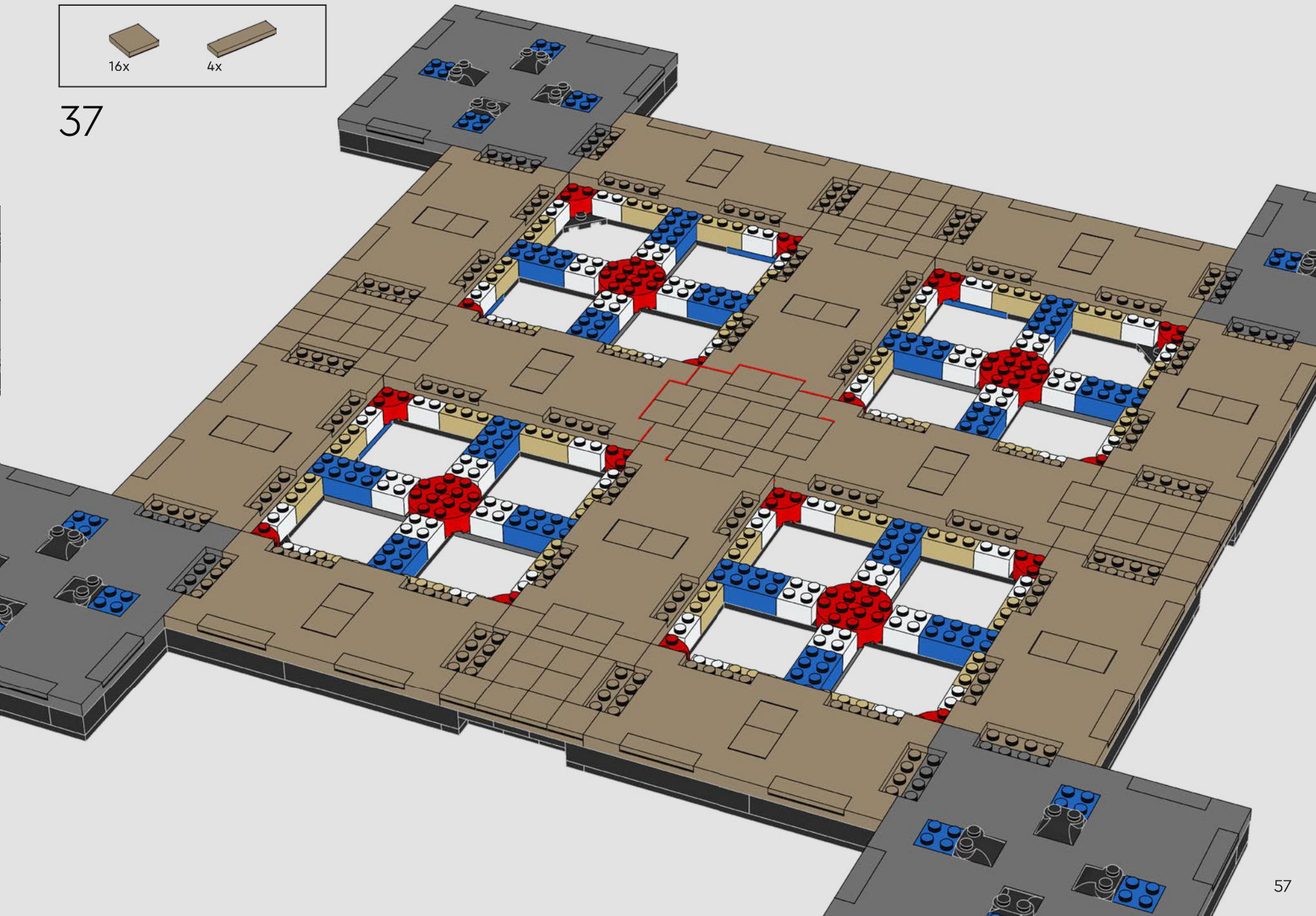

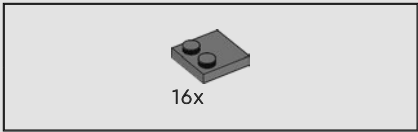

38

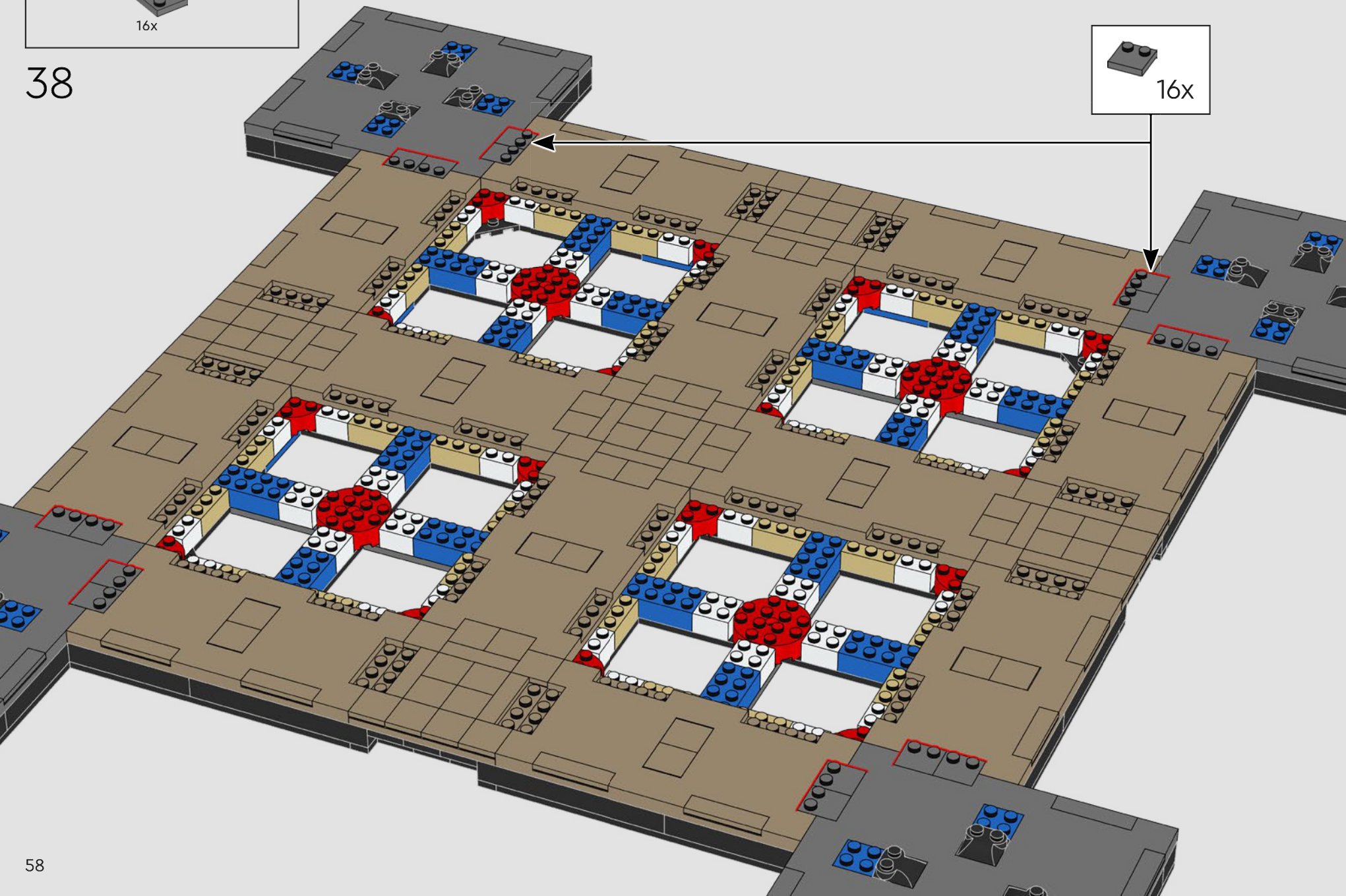
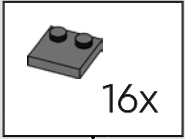

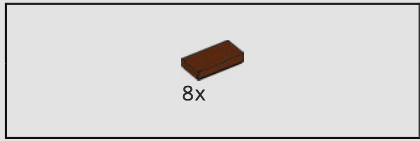

39

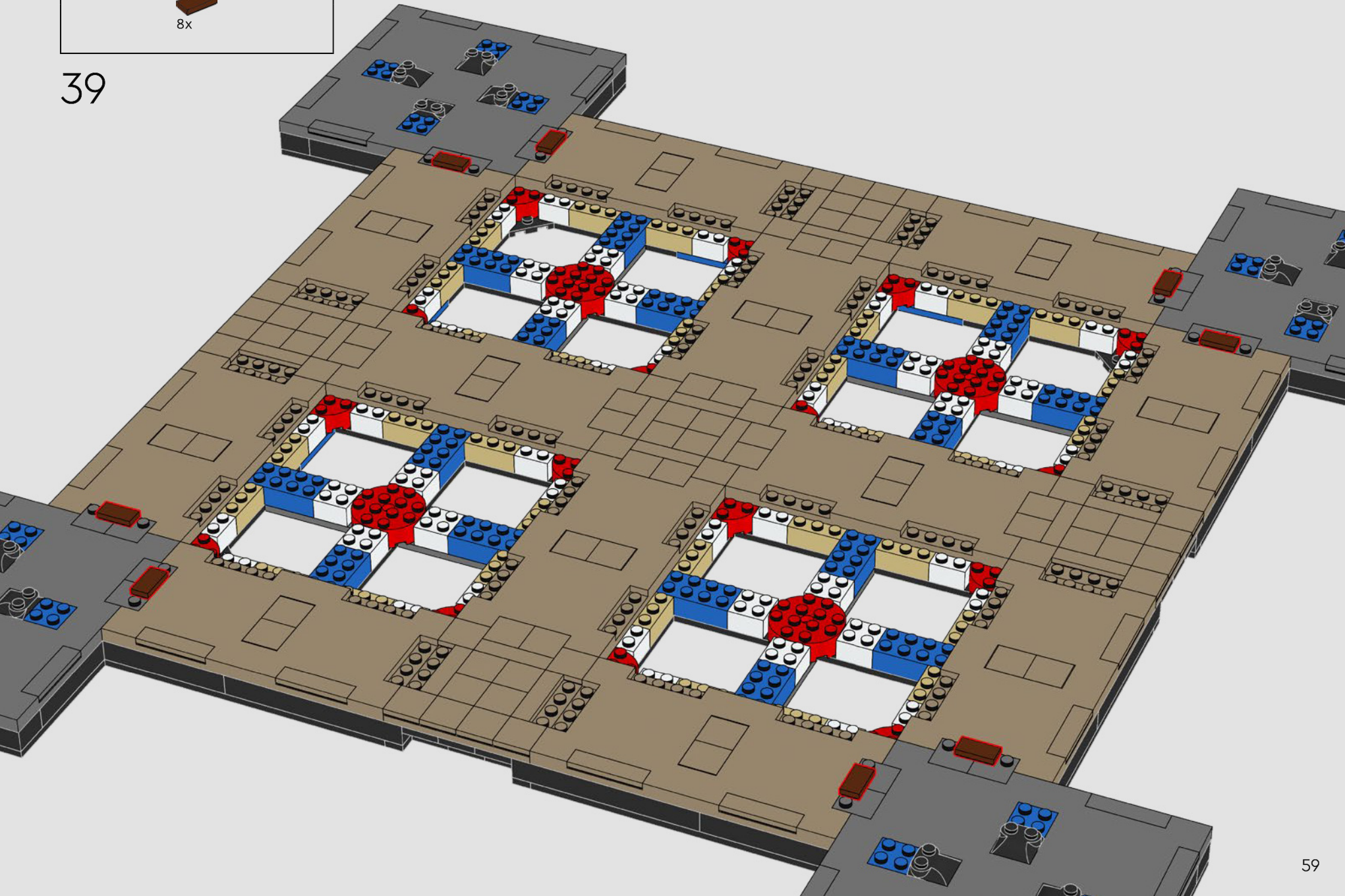

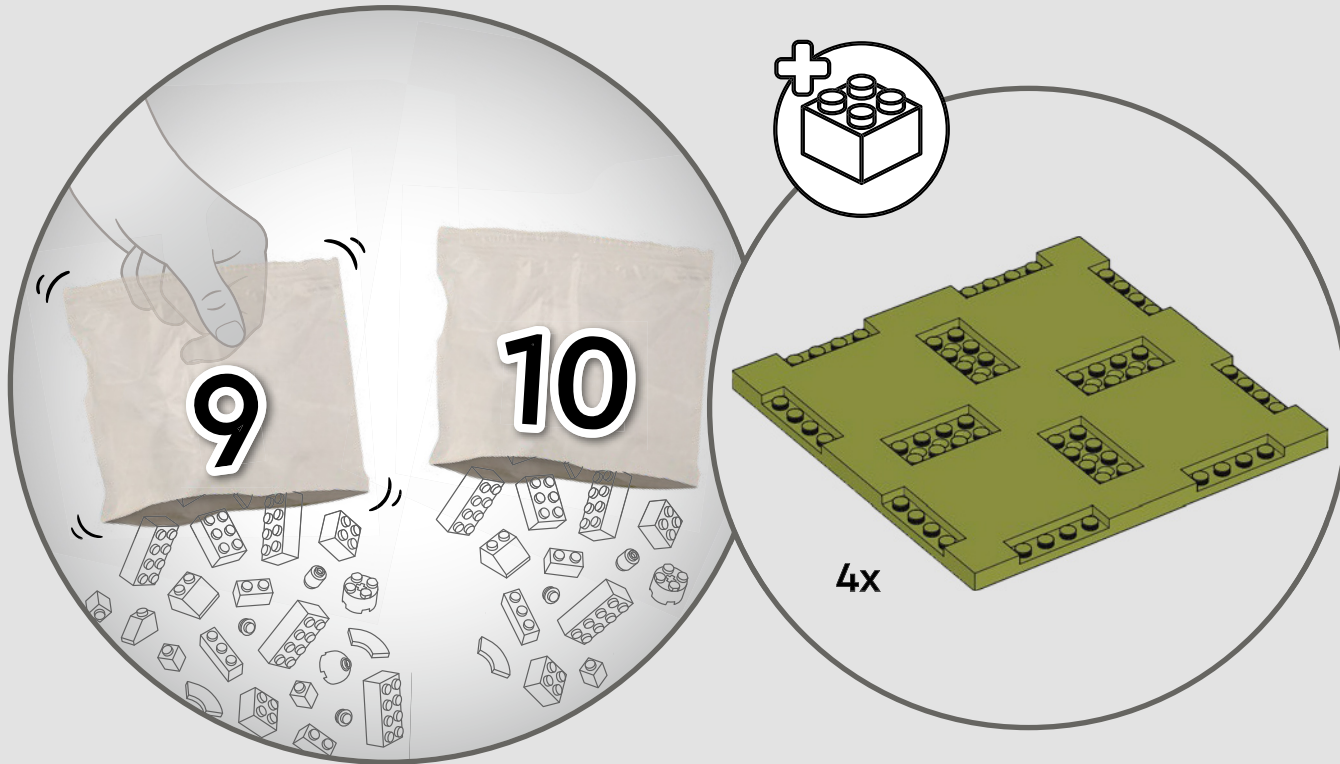

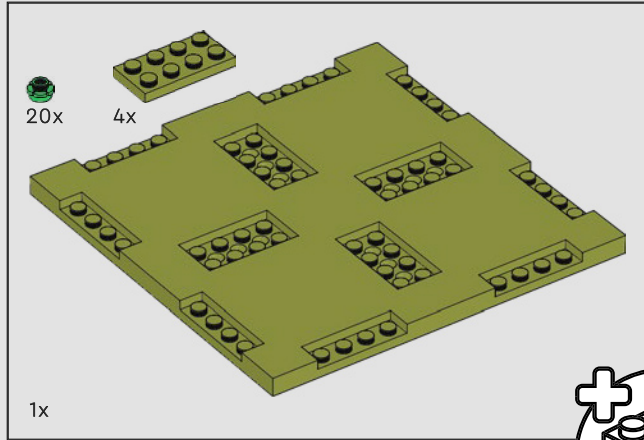
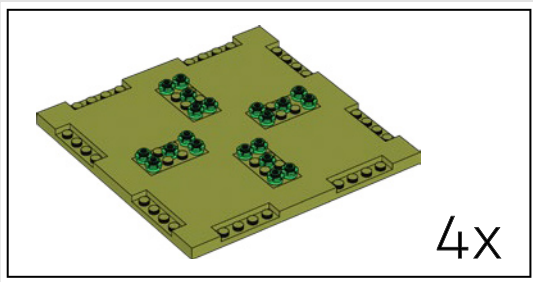

40

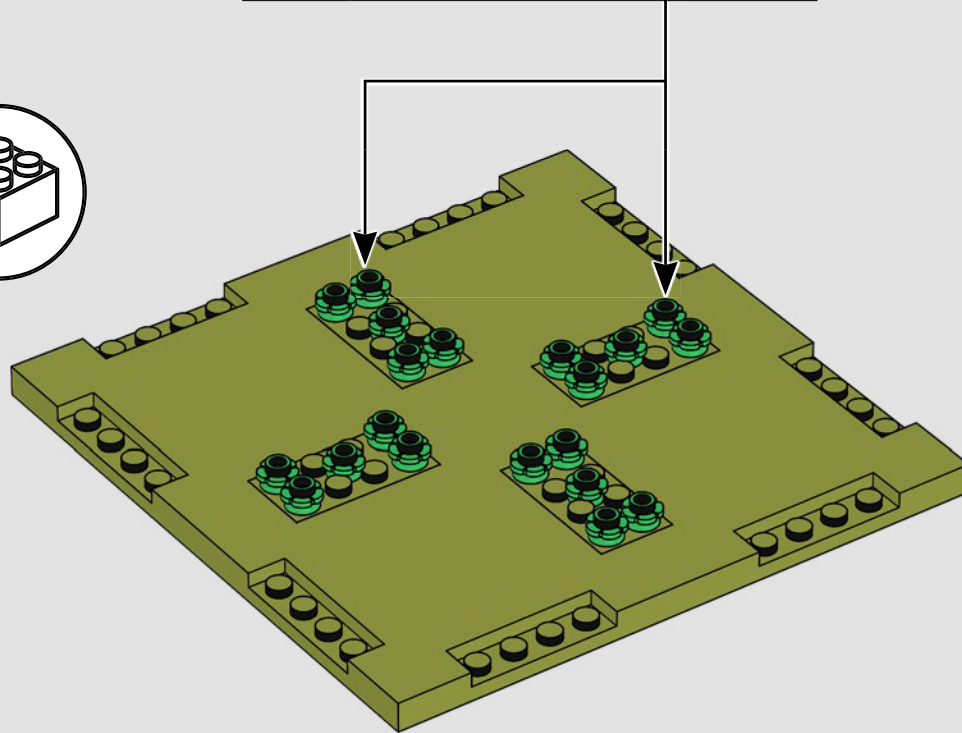
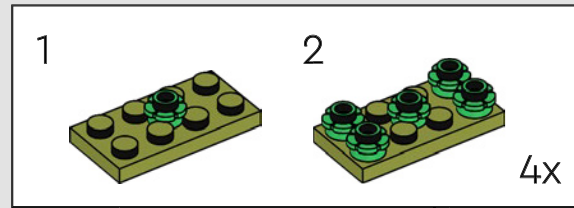
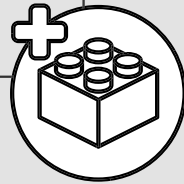

41

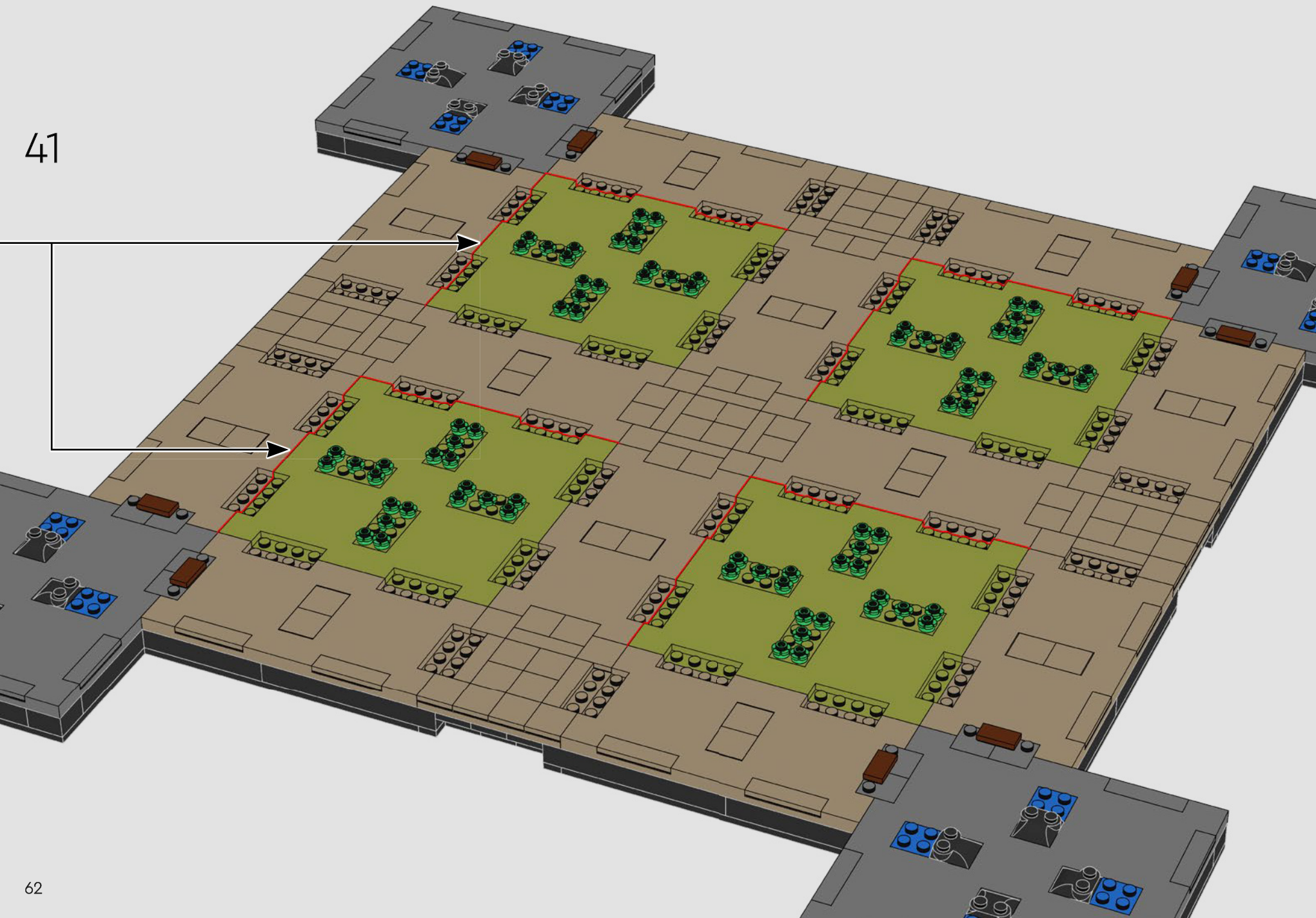

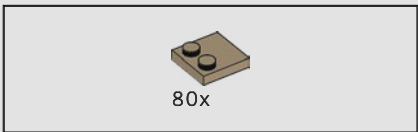

42

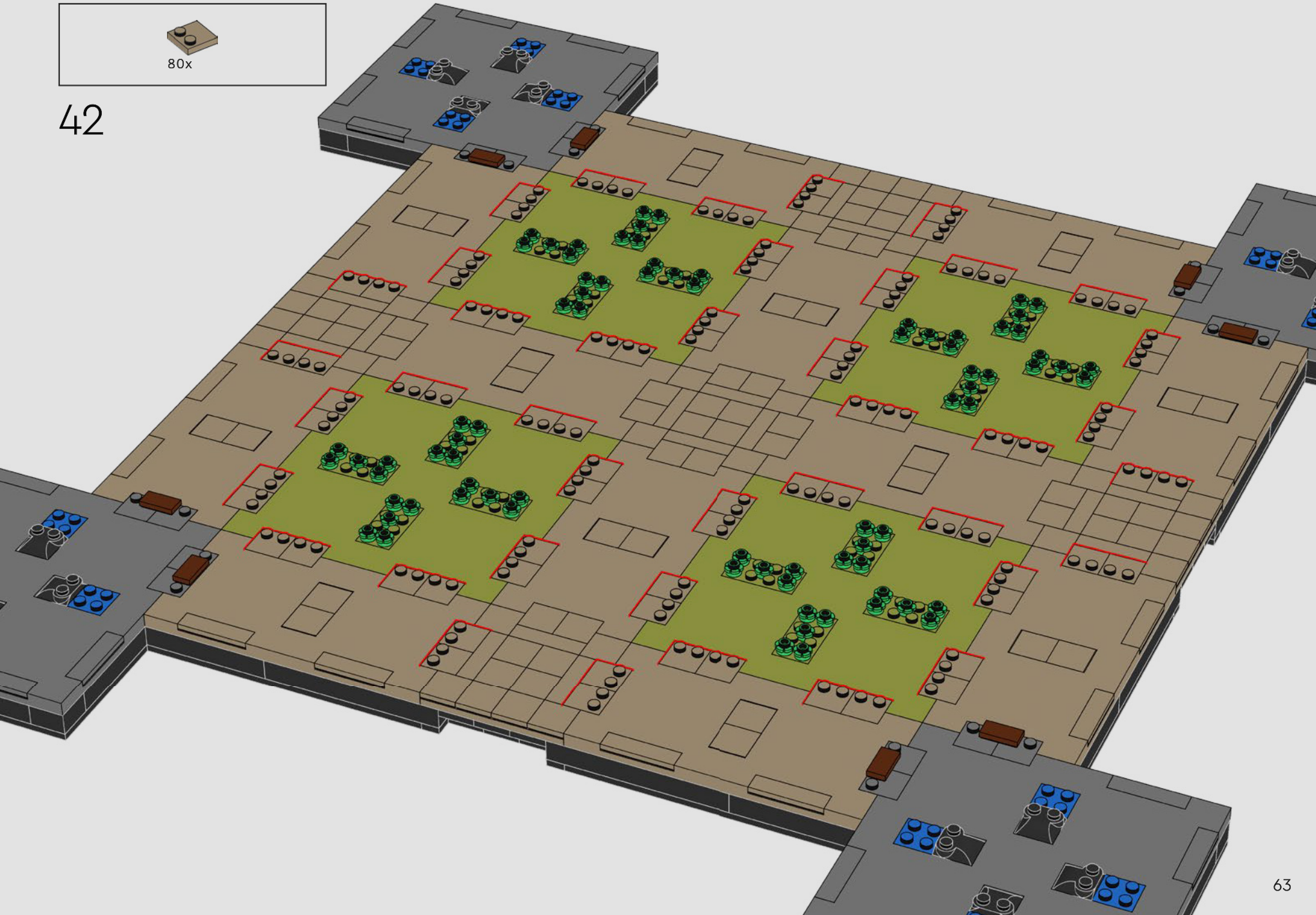



40x

43

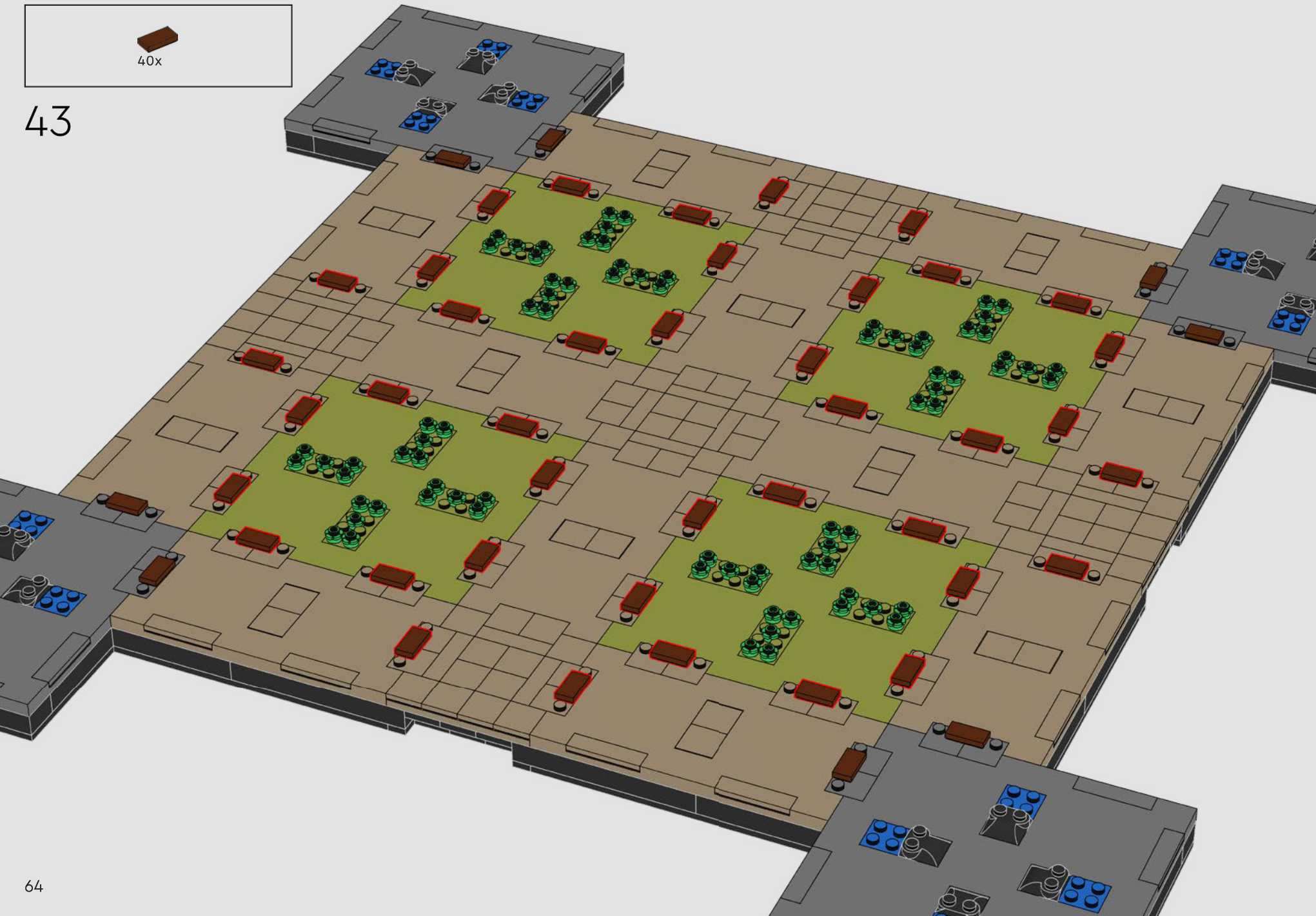

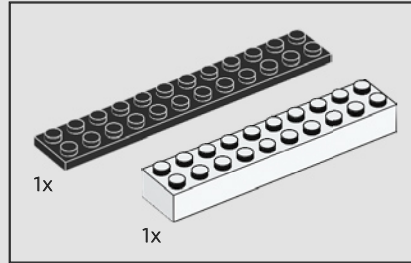
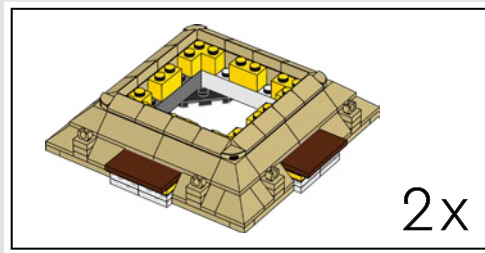

44

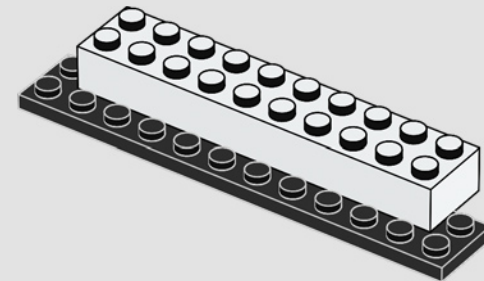

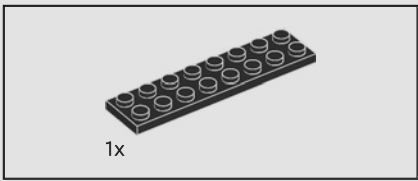

45

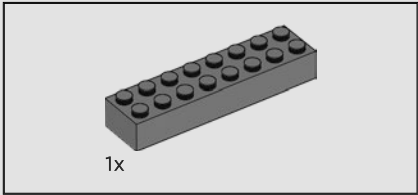
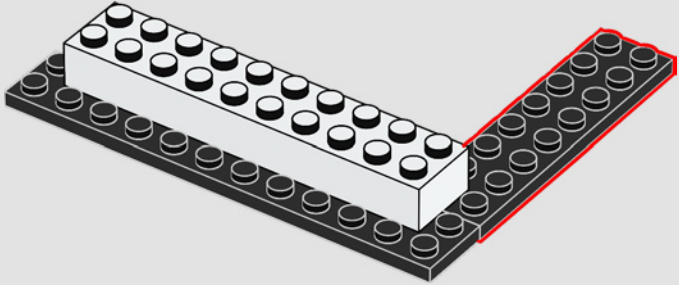

46

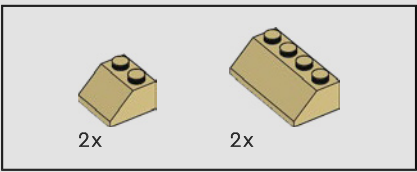
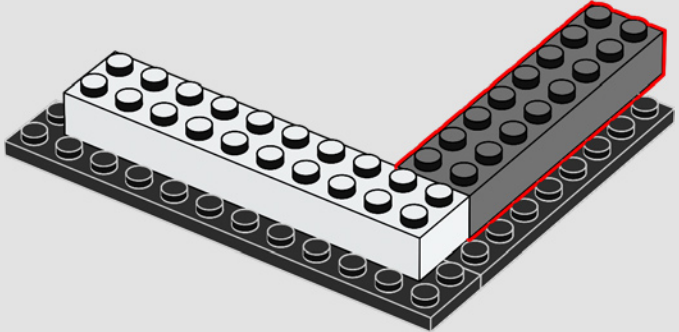

47

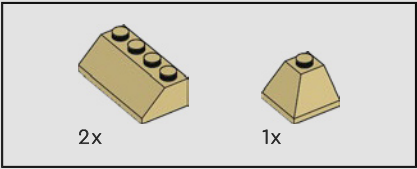
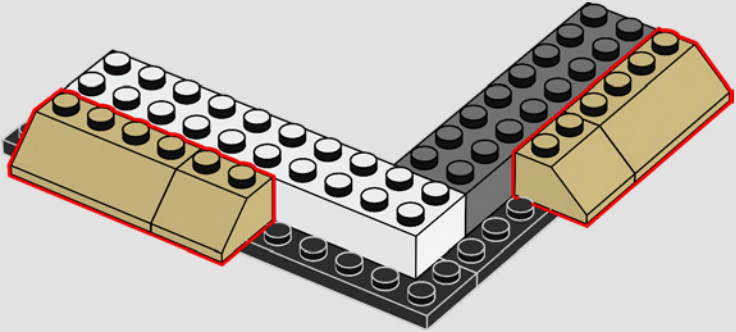

48

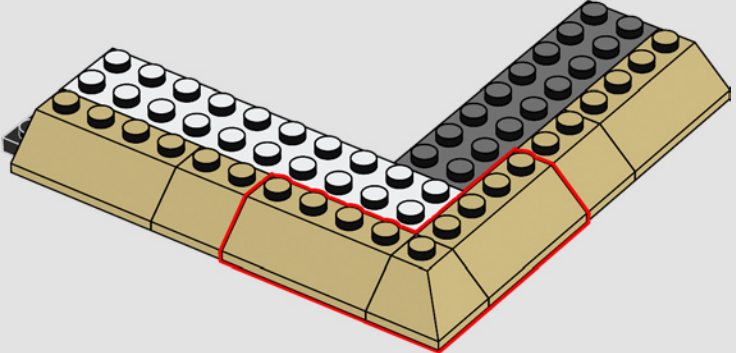

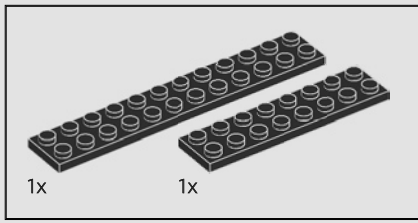

49

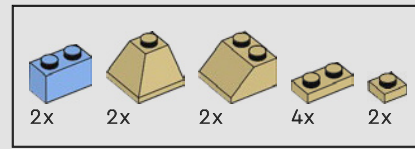
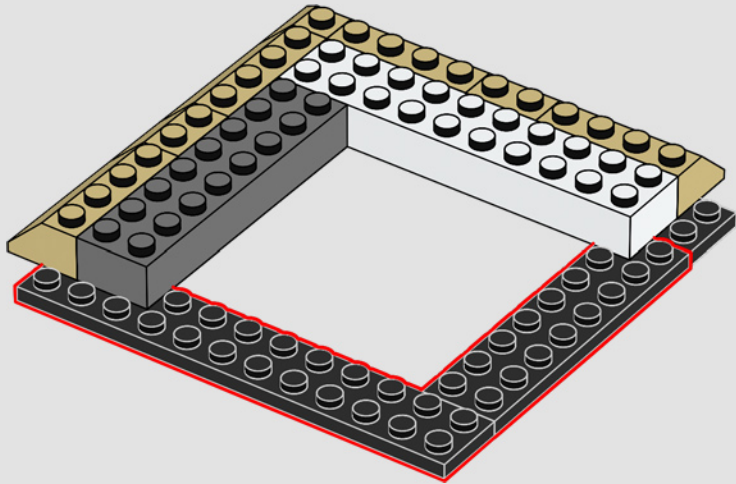

50

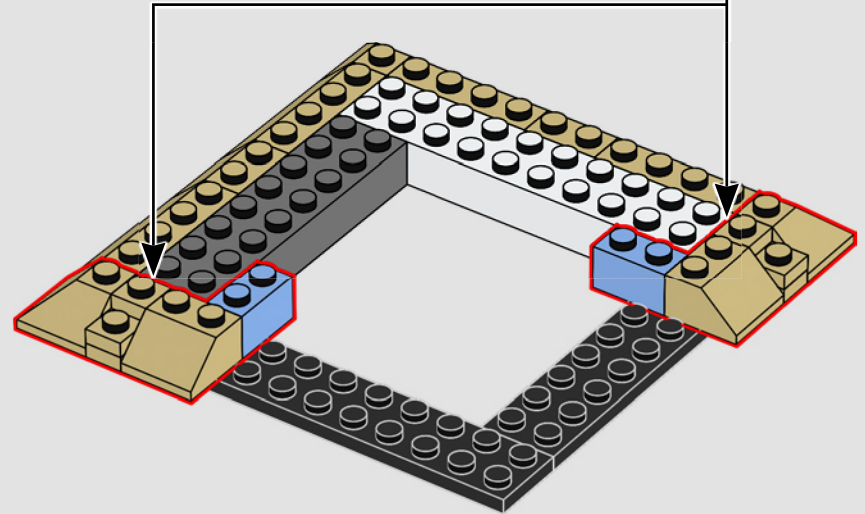
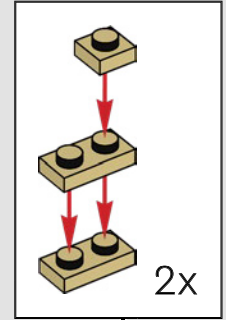

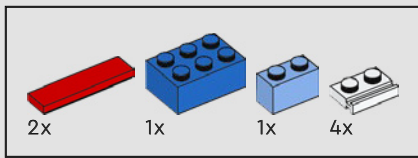

51

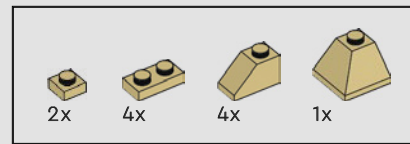
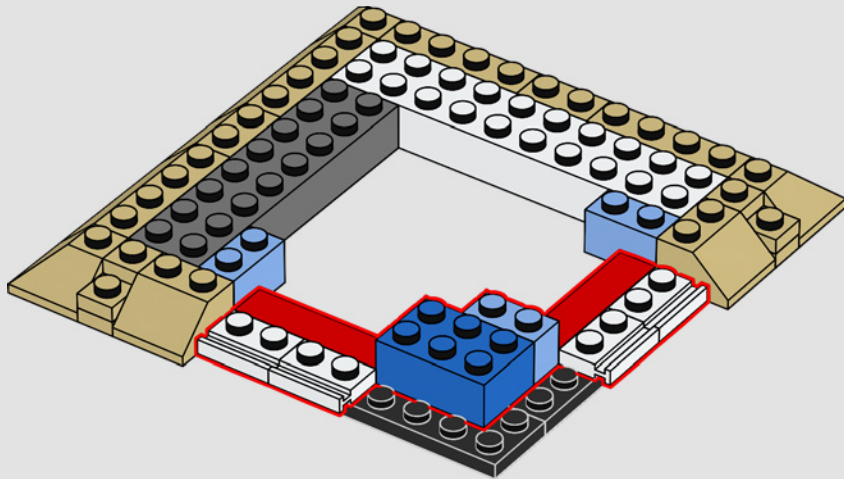

52

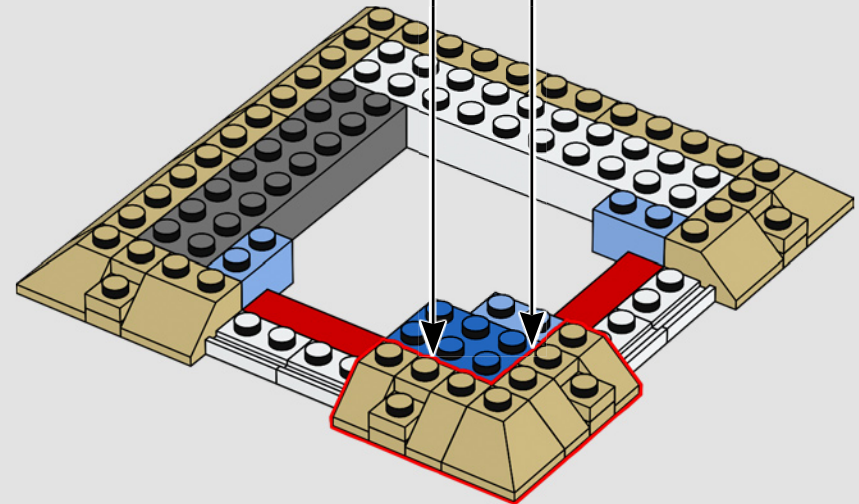
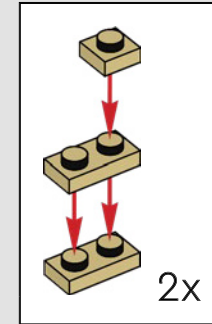

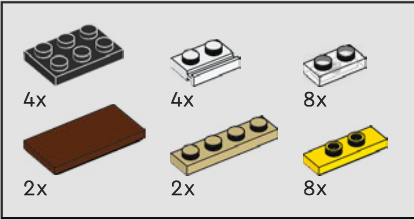

53

1

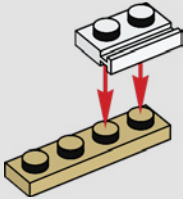

2

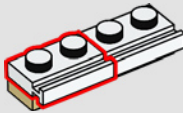

3

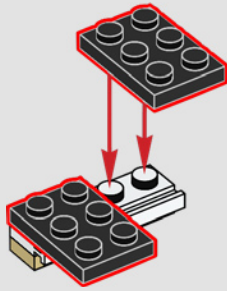

4

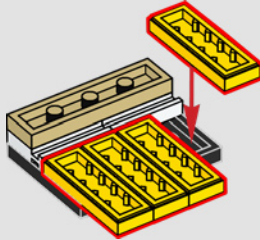

5

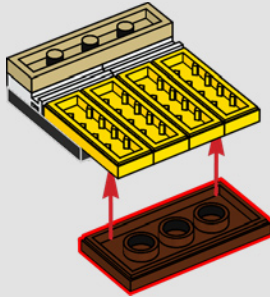

6

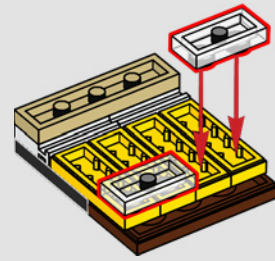

7

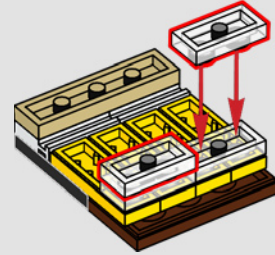

2x

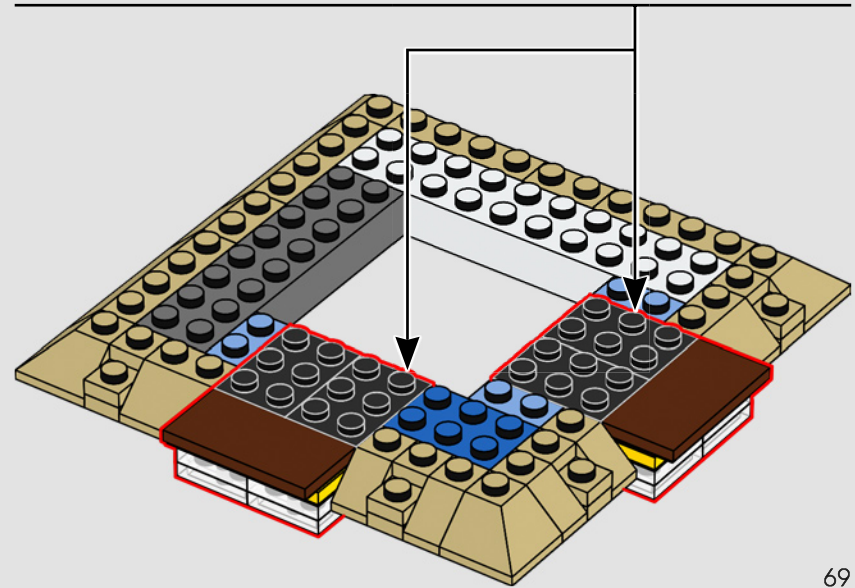



54

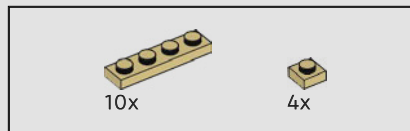
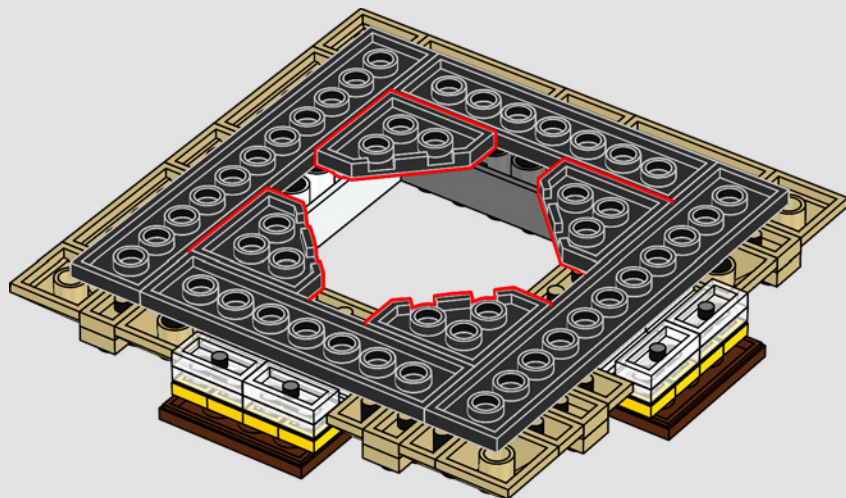

55

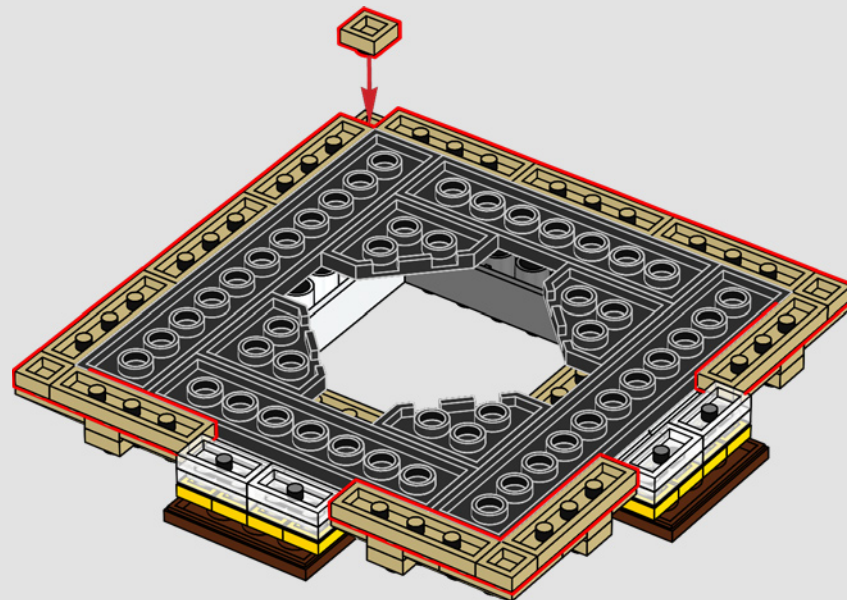

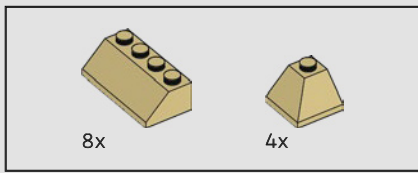

56

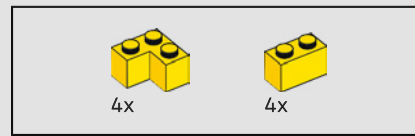
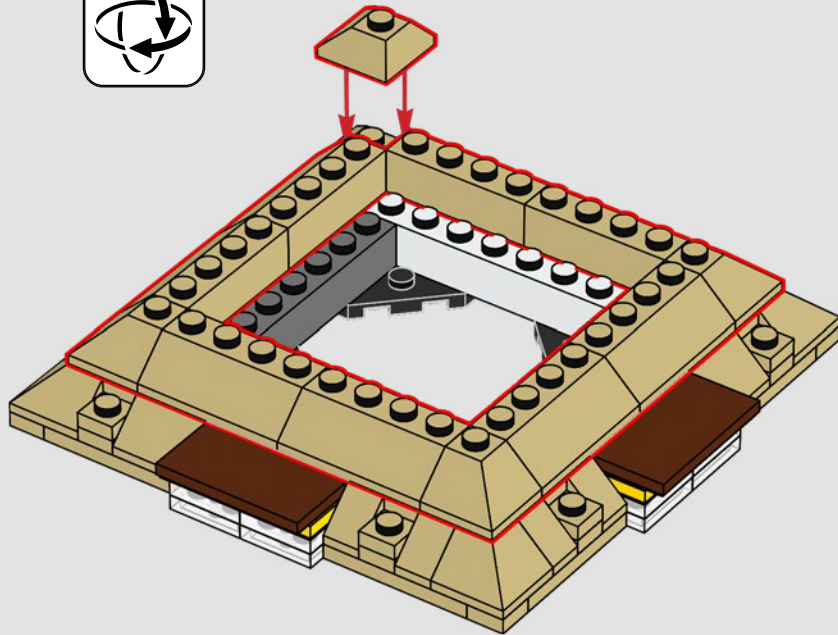

57

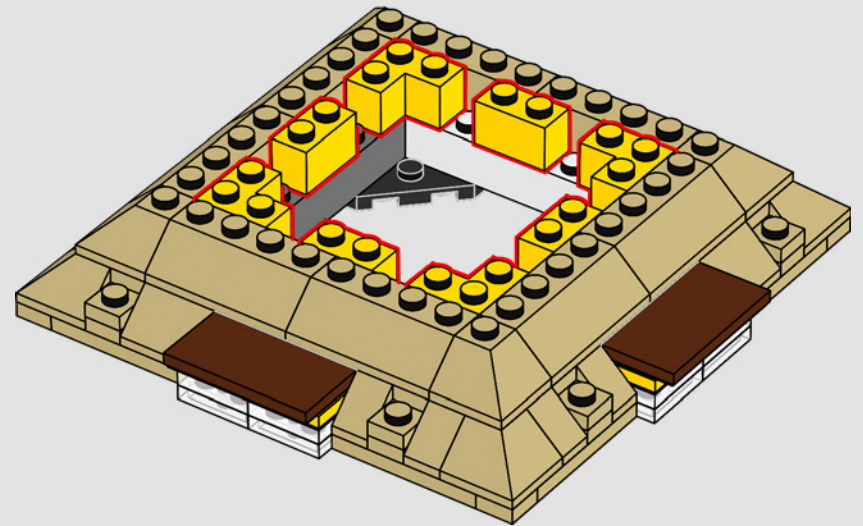



16x

58

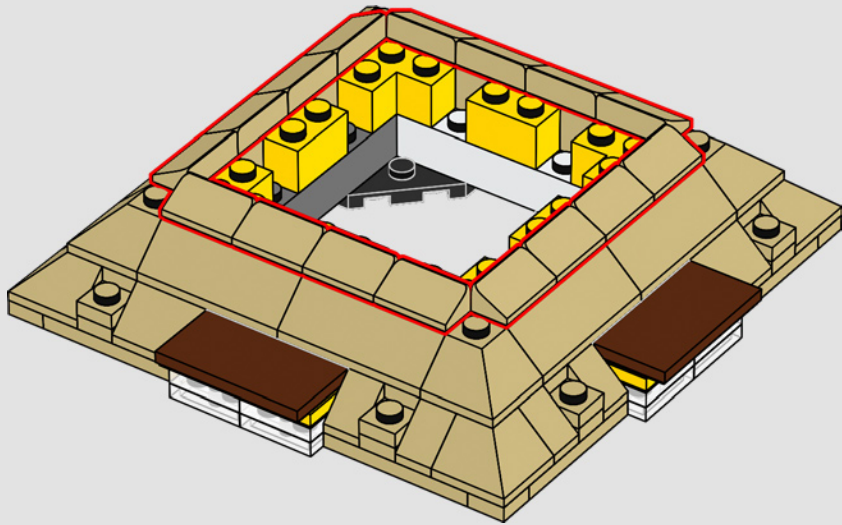

4x



4x

59

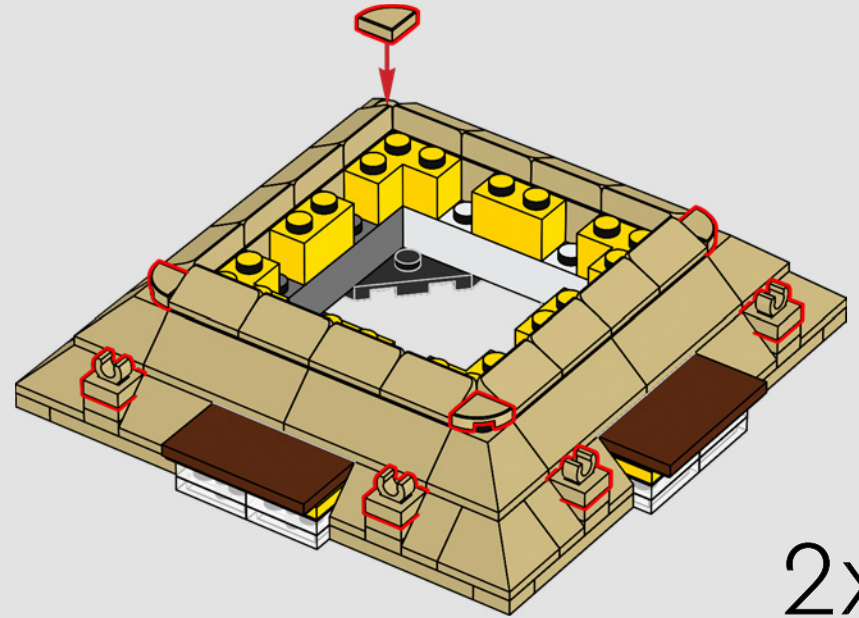

2x

60

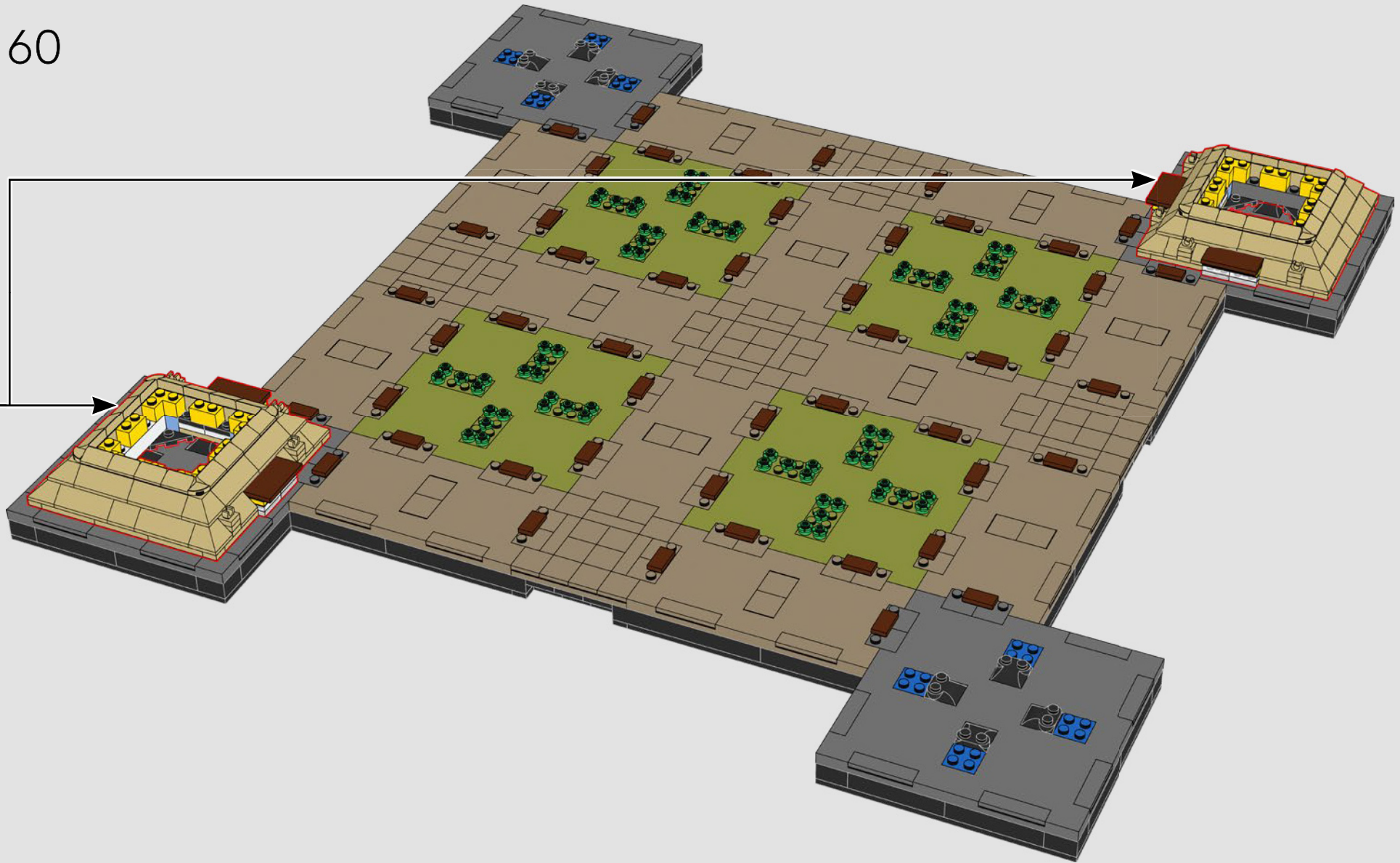

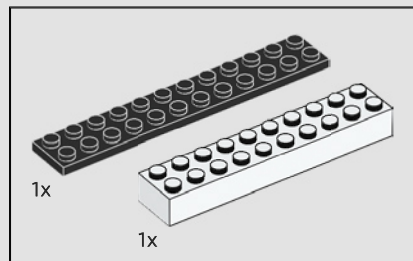
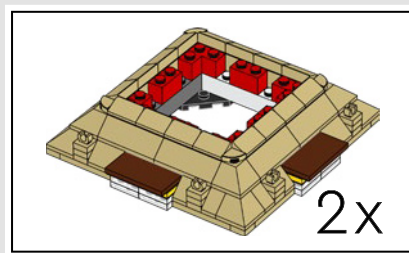

61

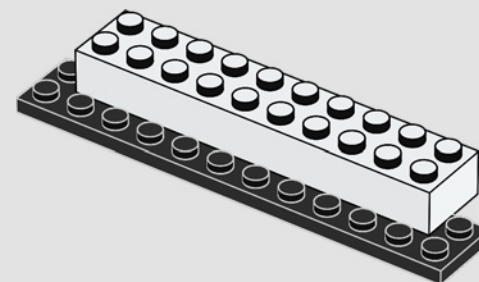

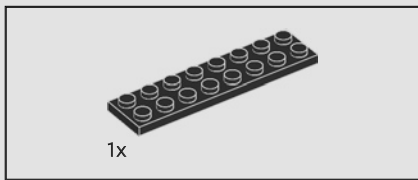

62

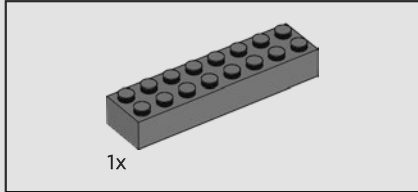
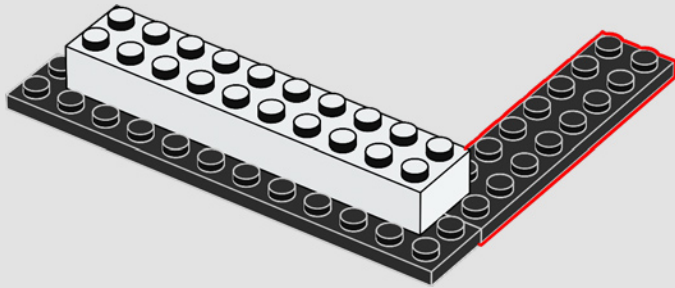

63

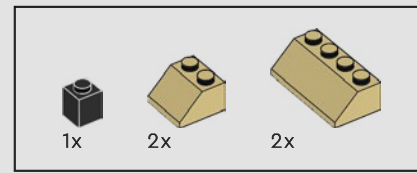
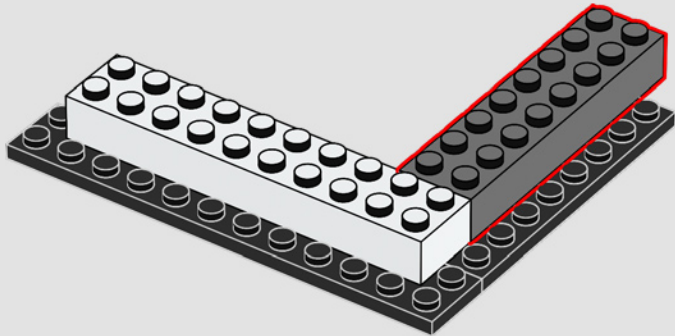

64

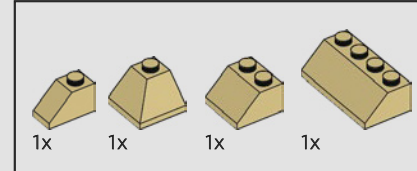
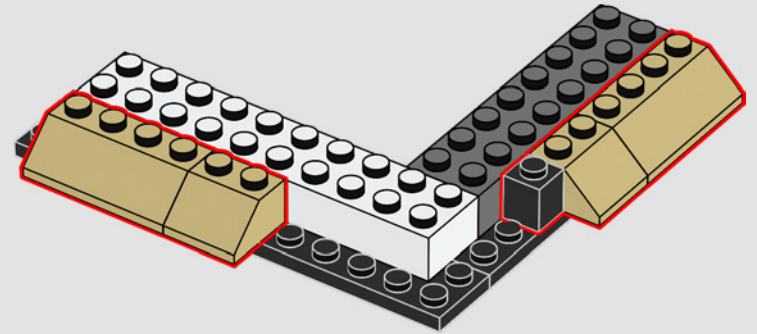

65

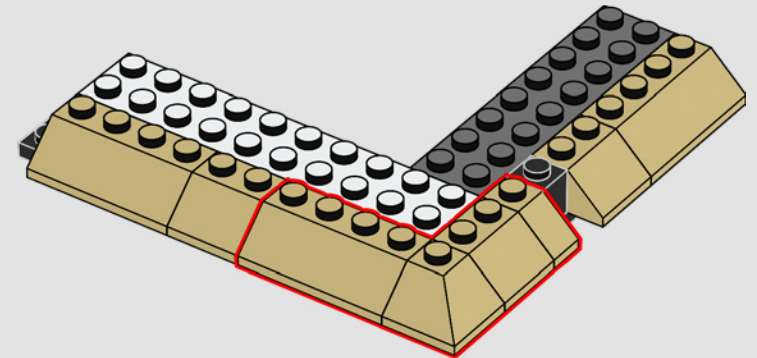

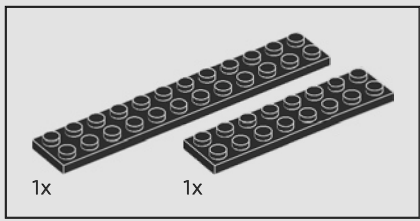

66

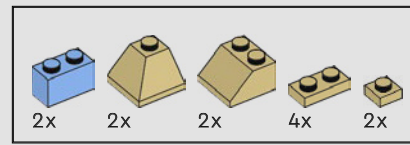
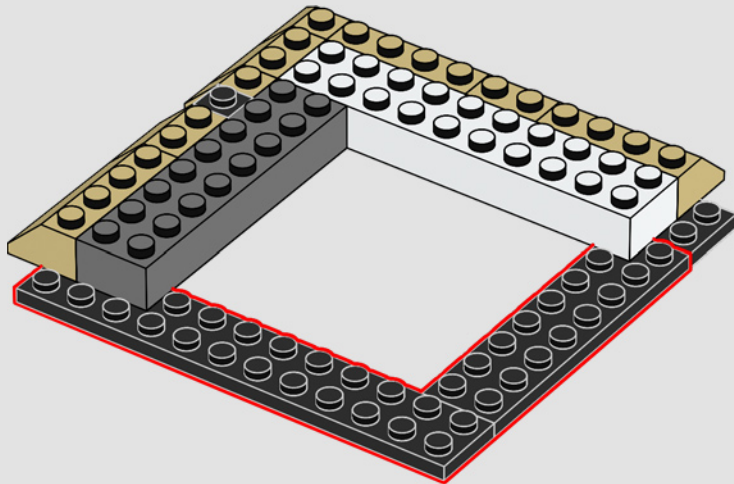

67

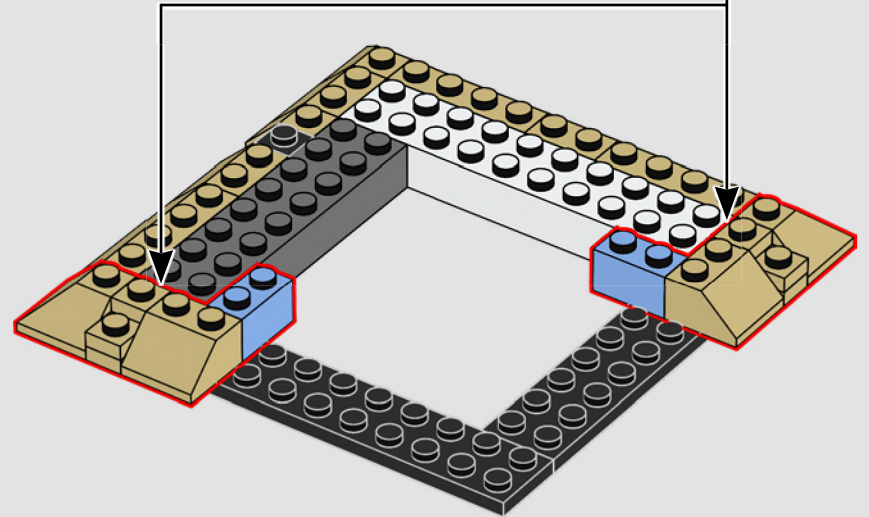
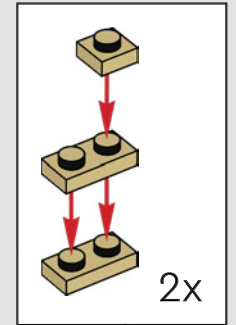

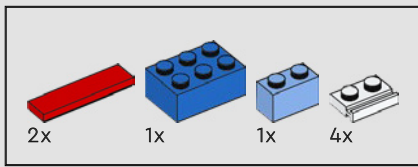

68

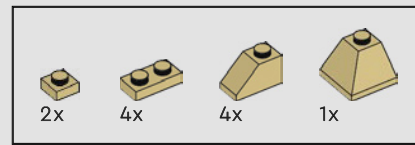
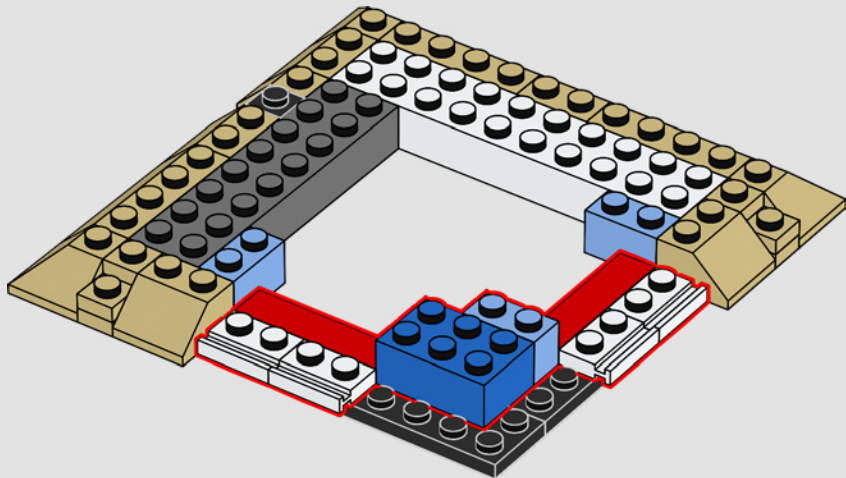

69

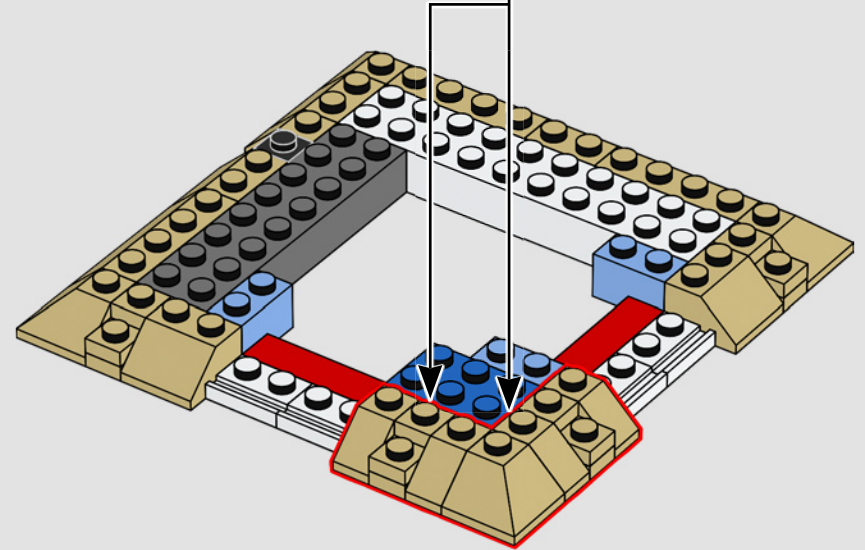
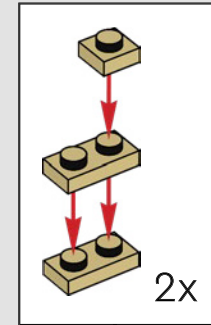

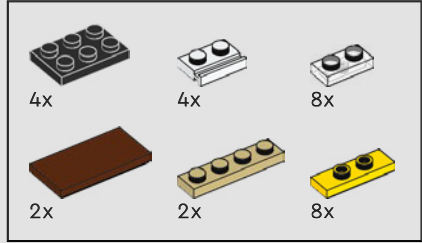
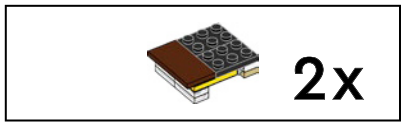

70

1

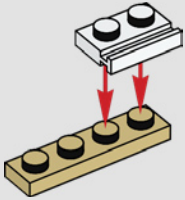

2

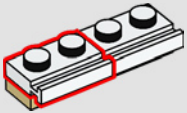

3

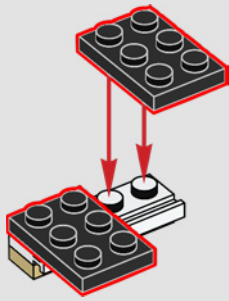

4

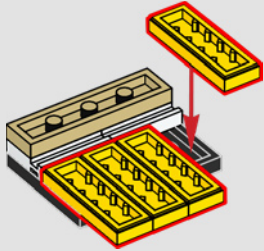

5

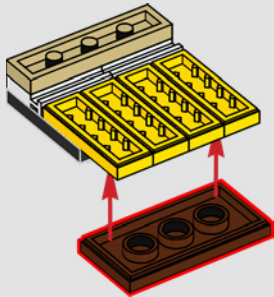

6

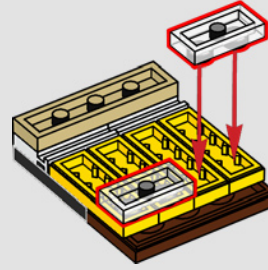

7

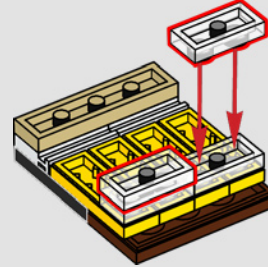

2x

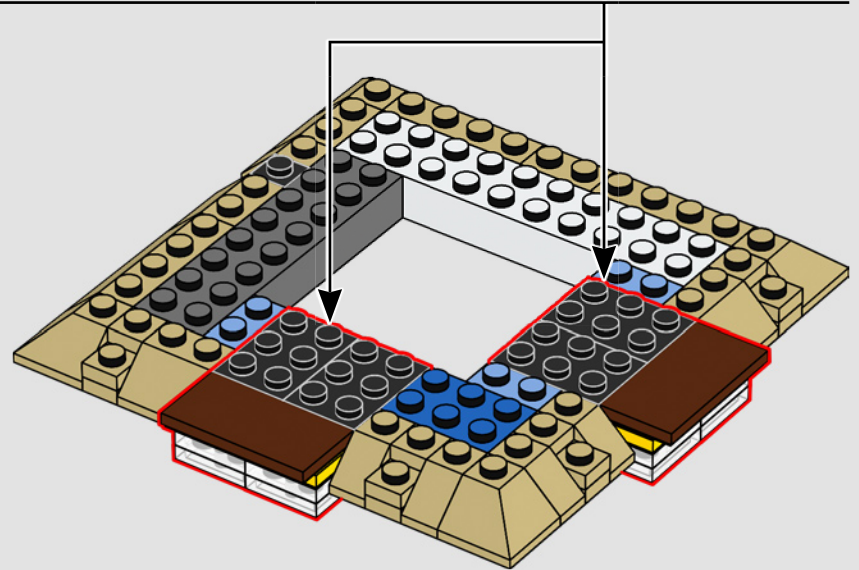

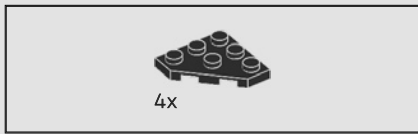

71

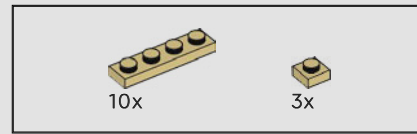
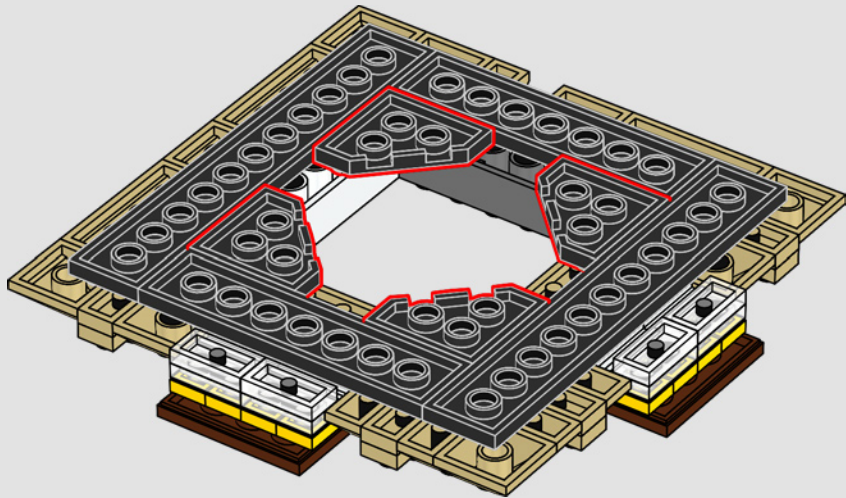

72

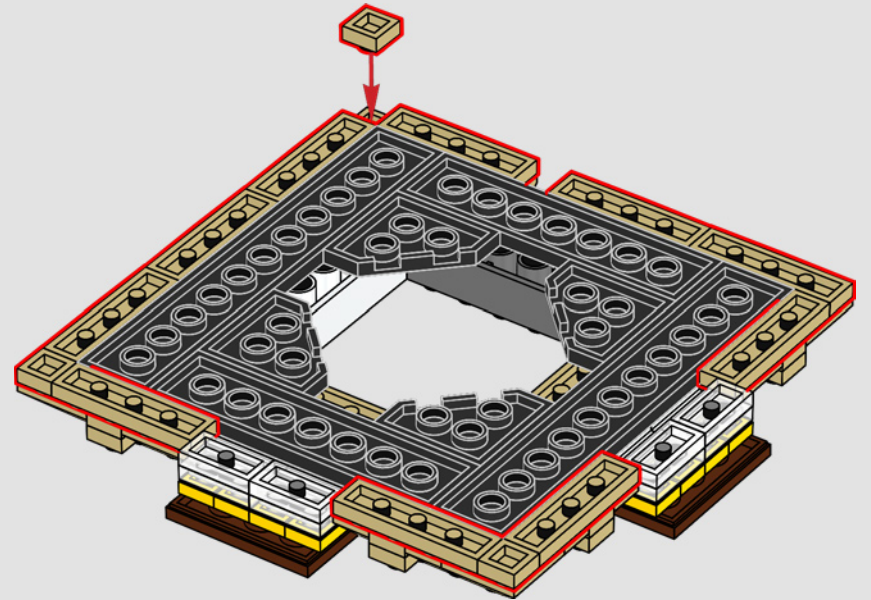

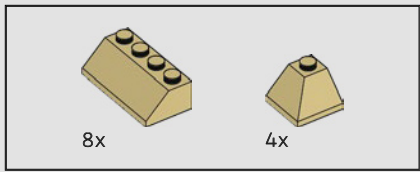

73

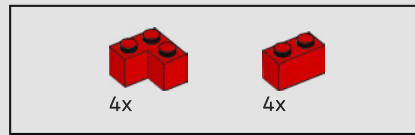
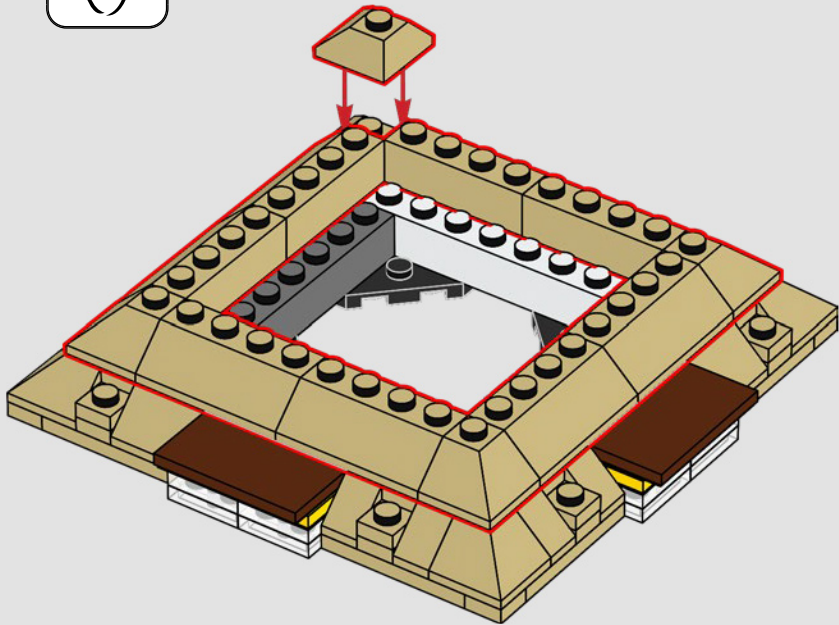

74

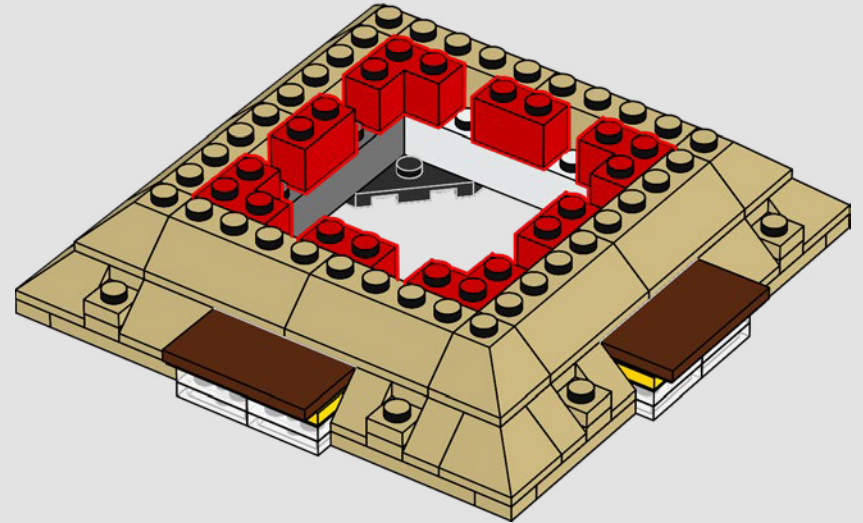

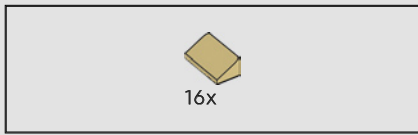

75

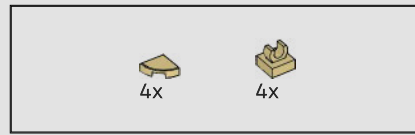
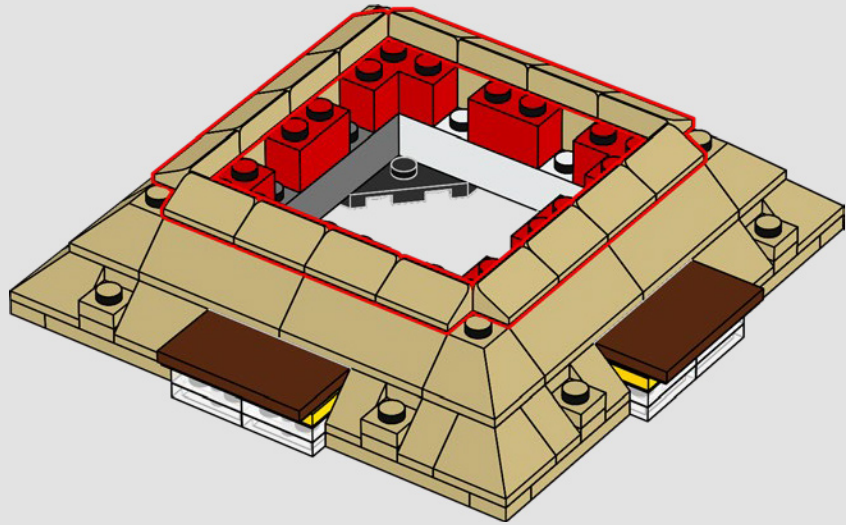

76

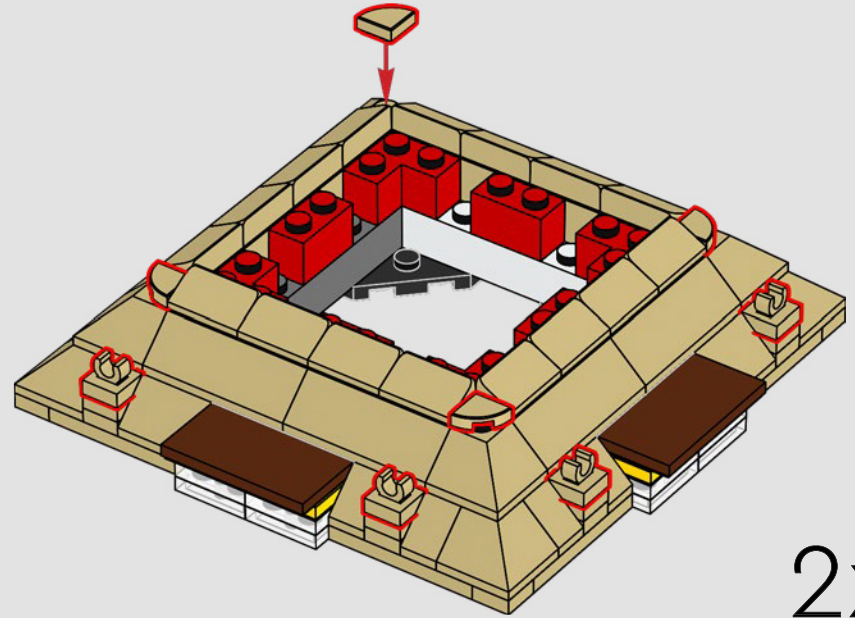

2x

77

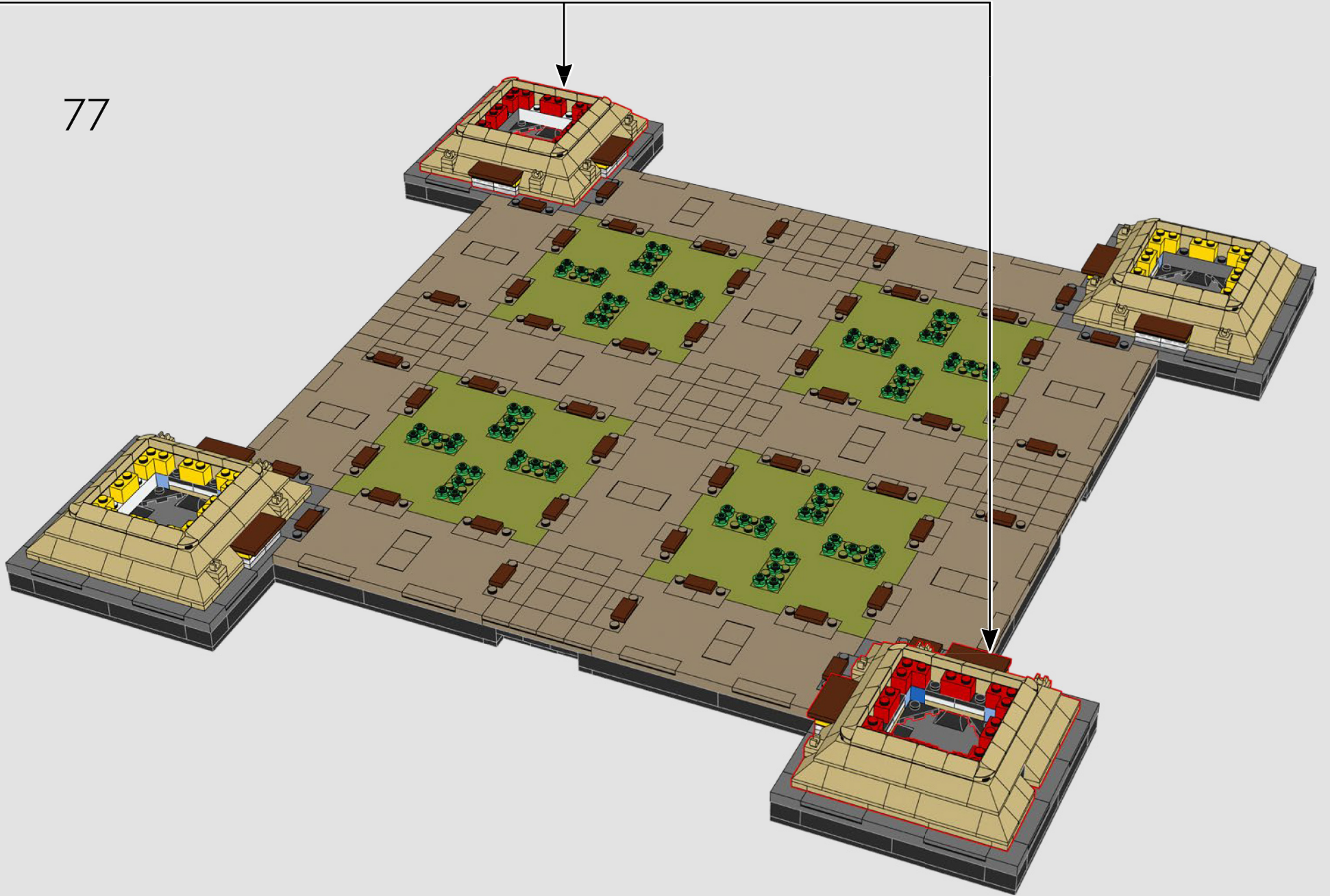



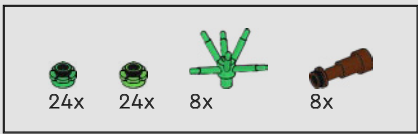

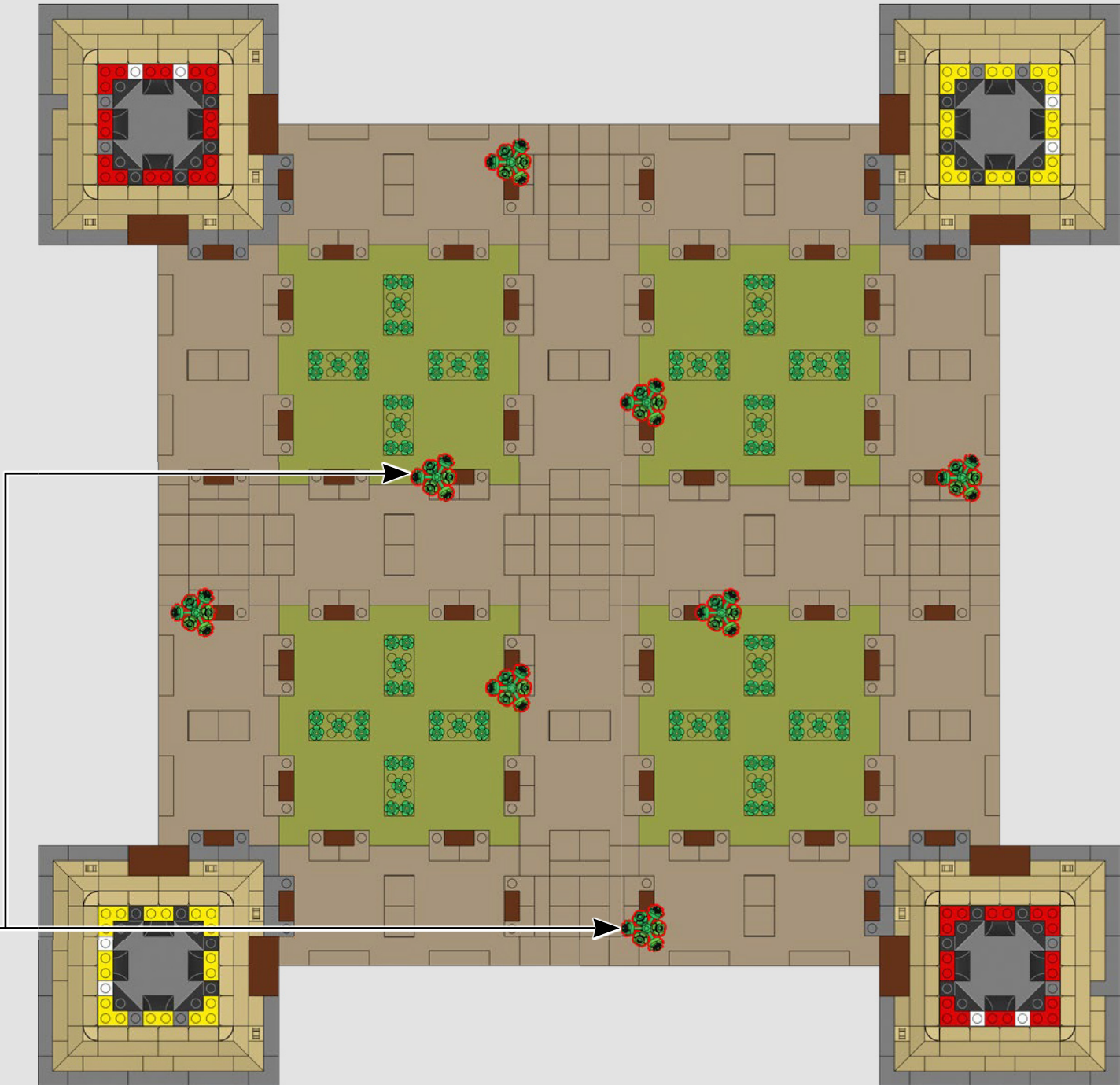
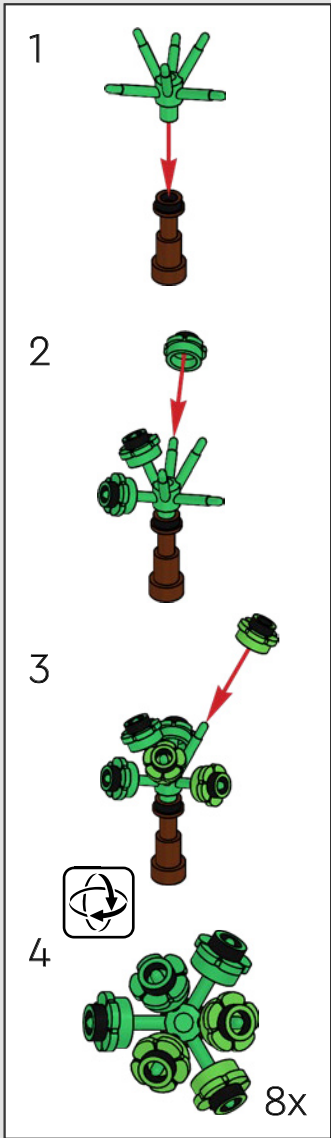

78



64x

79

1 

2 

 32x

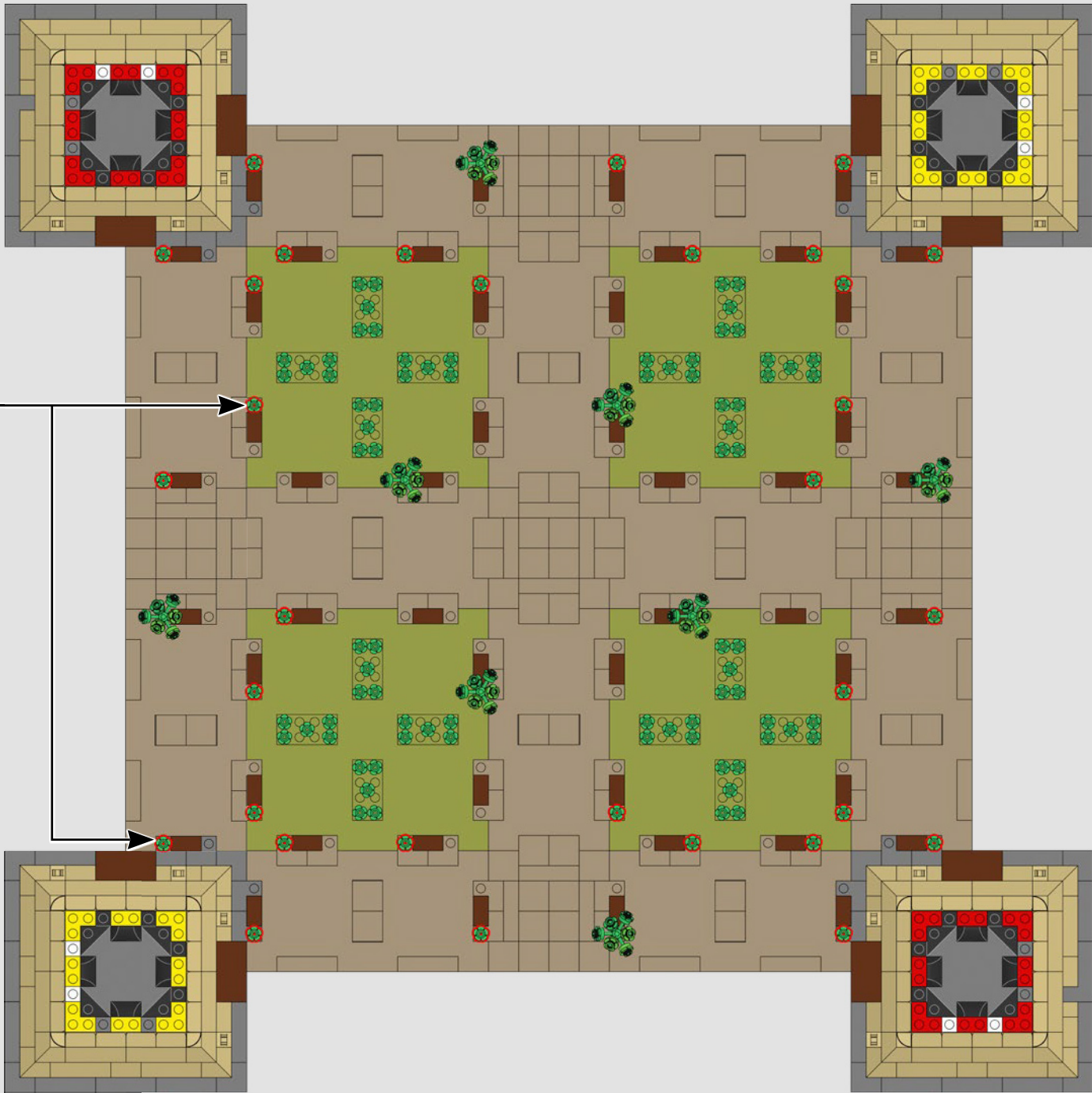



80

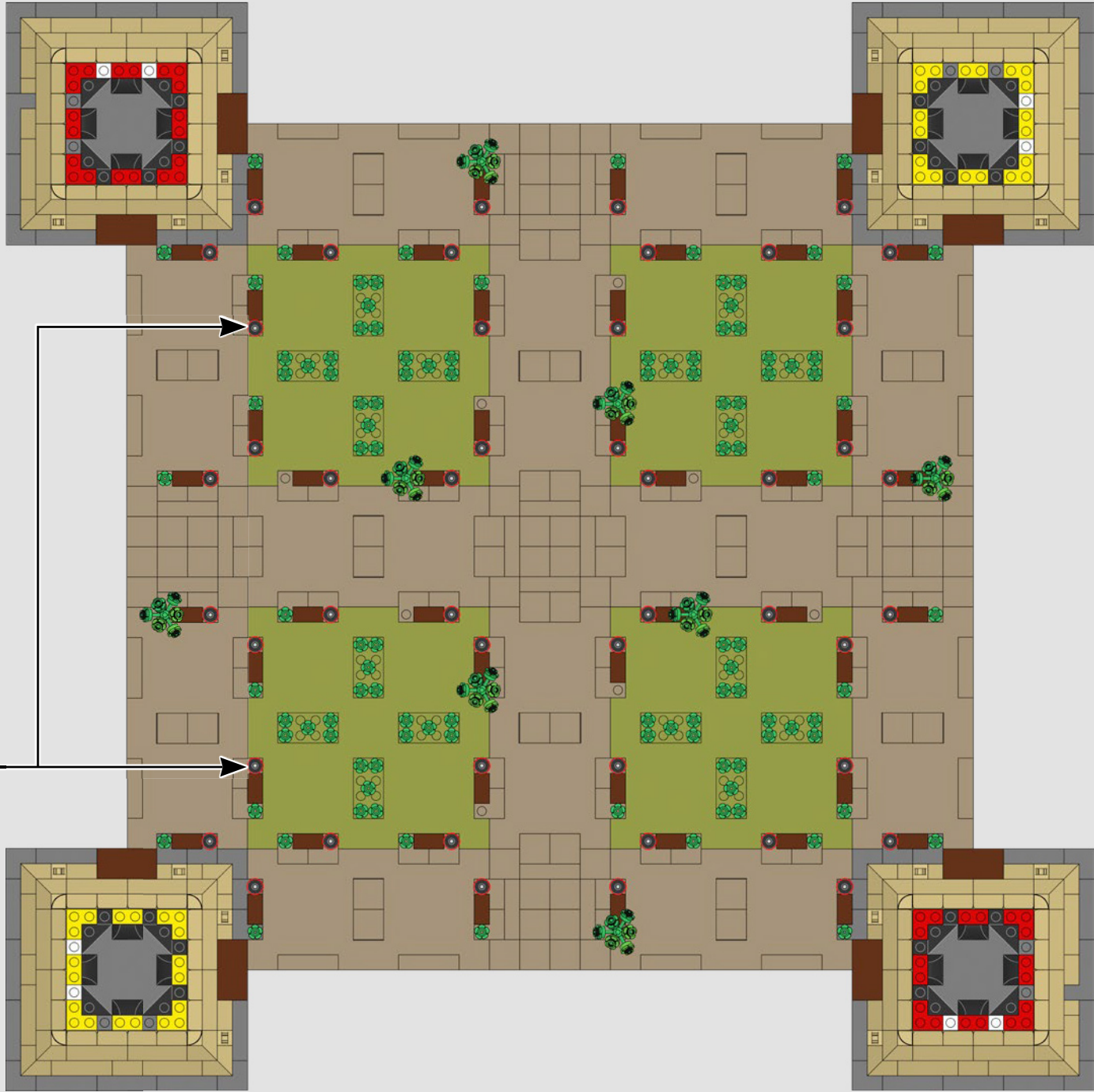
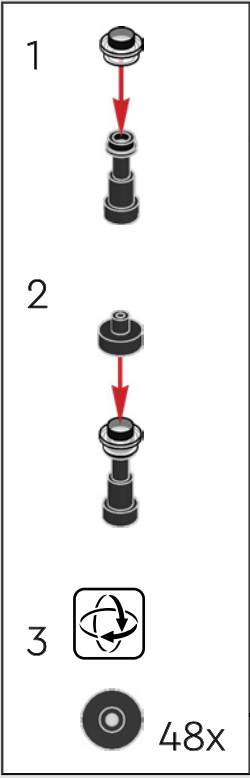



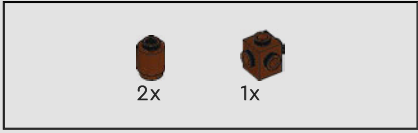
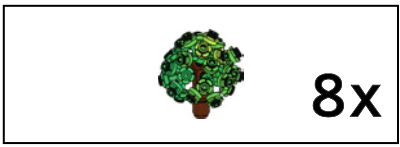

81

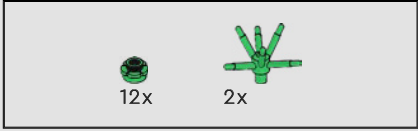

82

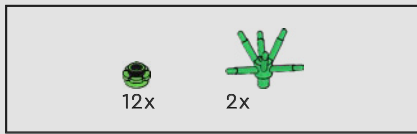
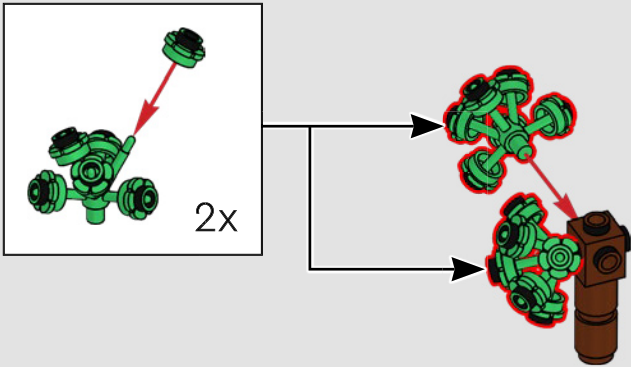

83

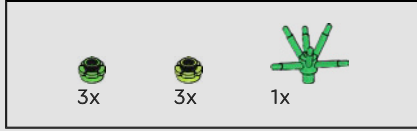
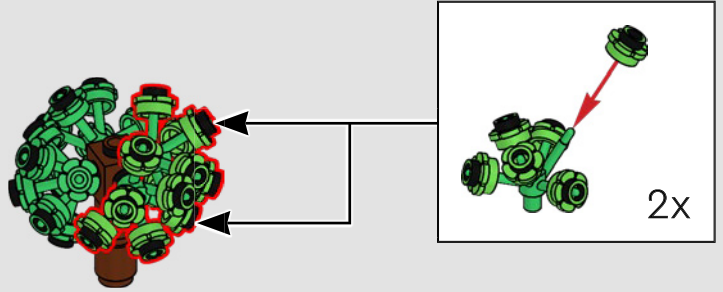

84

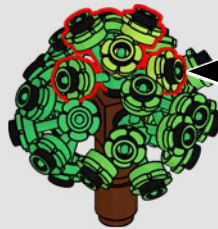
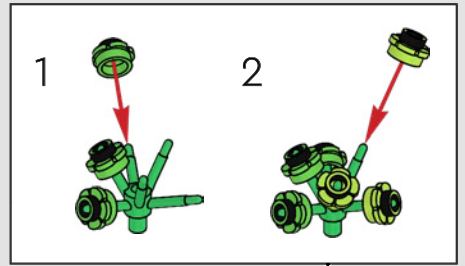

85

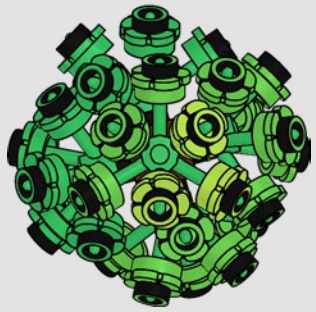

8x

86

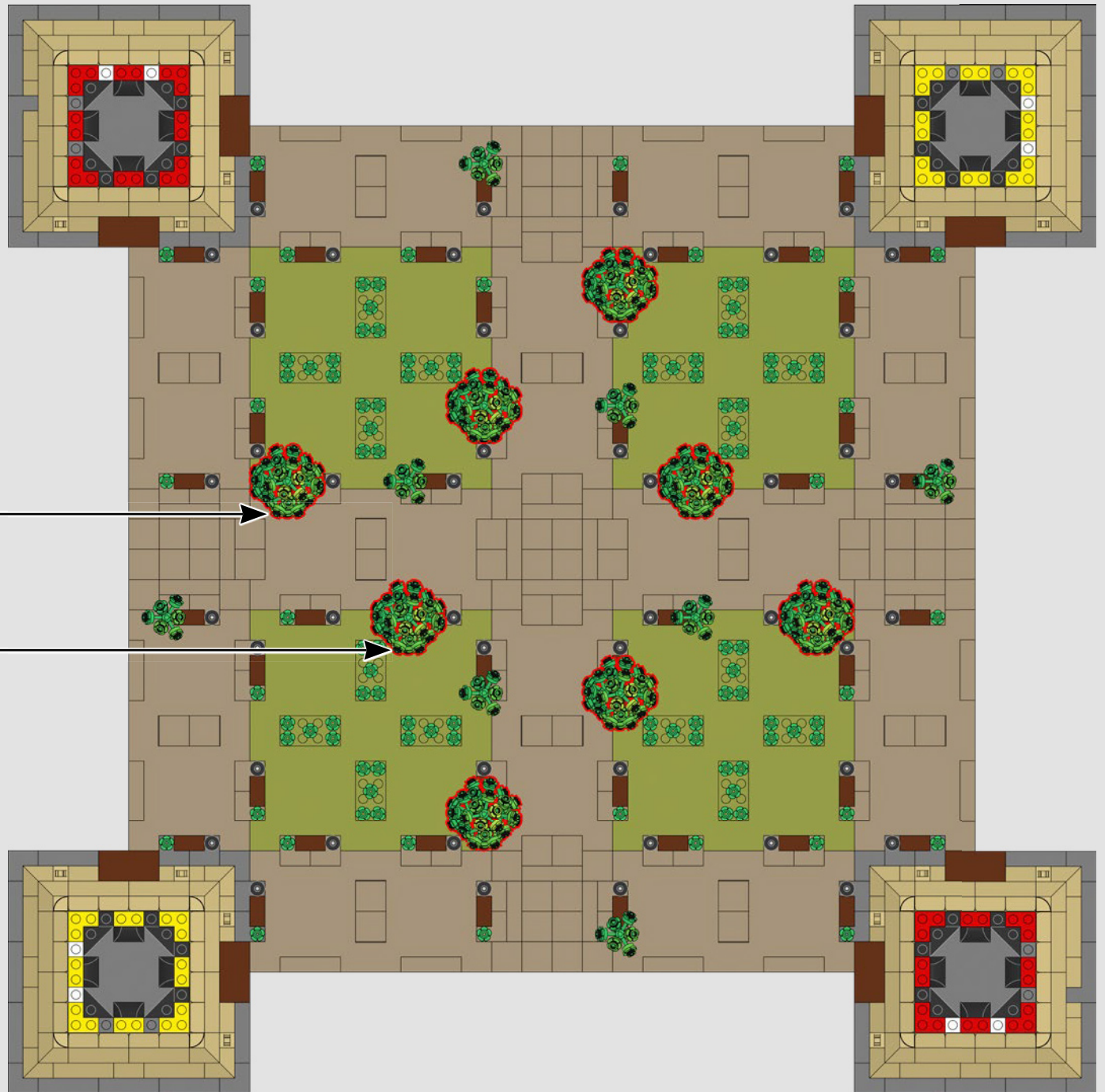



La base del modello LEGO® allude all'inaugurazione della torre nel 19° secolo, con sentieri paesaggistici aperti vivacizzati dal verde, lampioni e panchine tipici di Parigi.

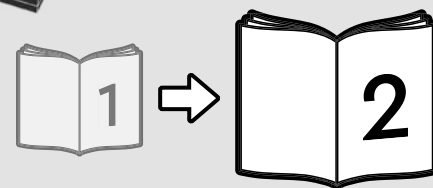



FEEDBACK AND WIN



FEEDBACK AND WIN

Your feedback will help shape the future development of this product series.

Please visit:

FEEDBACK UND GEWINNEN

Dein Feedback trägt zur Weiterentwicklung dieser Produktreihe bei.

Geh auf:

COMMENTEZ ET GAGNEZ

Vos commentaires nous aideront à concevoir les futurs produits de cette gamme.

Rendez-vous sur :

COMENTA Y GANA

Tu opinión nos ayudará a dar forma al desarrollo de esta serie de productos en el futuro.

Visita:

反馈有奖

您的反馈将有助于我们在今后改进本系列产品。

请访问：

[LEGO.com/productfeedback](https://www.lego.com/productfeedback)

By completing, you will automatically enter a drawing to win a LEGO® set.

Terms & Conditions apply.

Durch Ausfüllen nimmst du automatisch an der Verlosung eines LEGO® Preises teil.

Es gelten die Teilnahmebedingungen.

En envoyant vos commentaires, vous serez automatiquement inscrit(e) à un tirage au sort qui vous permettra de remporter un prix LEGO®.

Offre soumise à conditions.

Al contestar, participarás automáticamente en el sorteo y podrás ganar un set LEGO®.

Sujeto a Términos y Condiciones.

完成我们的反馈调查，即可自动进入抽奖环节，赢取乐高®套装。

适用《条款和条件》。

